



SERIE FORJA WROUGHT IRON

Grapas-Boca de pez.....	50
<i>Clamps-Fishmouth.....</i>	<i>50</i>
Adornos.....	51-67
<i>Ornaments.....</i>	<i>51-67</i>
Arranques.....	68
<i>Posts.....</i>	<i>68</i>
Balaustres.....	69-83
<i>Balusters.....</i>	<i>69-83</i>
Barras.....	84-85
<i>Bars.....</i>	<i>84-85</i>
Lanzas.....	86-88
<i>Spears.....</i>	<i>86-88</i>
Pletinas.....	89-96
<i>Flat bars.....</i>	<i>89-96</i>
Remates.....	97-98
<i>Post tops.....</i>	<i>97-98</i>
Rosetones.....	99-100
<i>Rosettes.....</i>	<i>99-100</i>

ABRAZADERAS/GRAPAS DE HIERRO FORJADO FORGING CLAMPS



Referencia/Reference	G-12	G-14	G-16	G-20	G-25	G-30	G-40
Material para/Material for	■ 12x12	■ 14x14	■ 16x16	■ 20x20	■ 25x25	■ 30x30	■ 40x40

Referencia/Reference	G-1-12	G-1-14	G-2-12	G-2-14
Material para/Material for	■ 12x12 + — 12x6	■ 14x14 + — 14x5	■ 12x12 + 2 — 12x6	■ 14x14 + 2 — 14x5

Referencia/Reference	G-2-16	G-4-12	G-4-14	G-14-2
Material para/Material for	■ 16x16 + 2 — 16x6	■ 12x12 + 4 — 12x6	■ 14x14 + 4 — 14x5	2 ■ 14x14

Referencia/Reference	H-2-12	H-2-14	H-2-16	H-3-12	H-3-14	H-3-16	H-4-14
Material para/Material for	2 — 12x6	2 — 14x5	2 — 16x6	3 — 12x6	3 — 14x5	3 — 16x6	4 — 14x5

Bajo pedido fabricamos otras medidas y acabados.
Under order, other measures and endings.

BOCA DE PEZ FISHMOUTH

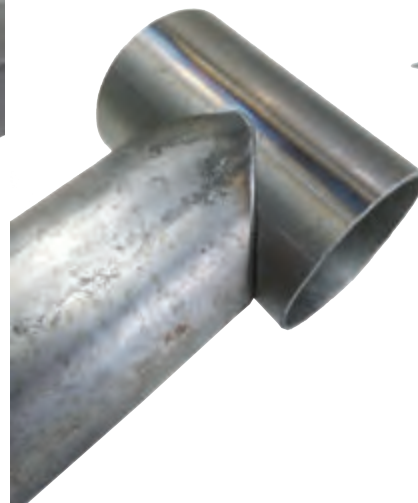

Bajo pedido fabricamos otras medidas y acabados.
Boca de pez siempre se acopla sobre un tubo redondo
siendo el tubo a acoplar redondo, cuadrado o rectangular.

*Under order, other measures and endings.
Fishmouth always engages on a round tube,
fishmouth can be done over round, square and rectangular pipes.*



Referencia/Reference	AD-001-12
Material/Material	■ 12
Alto/High	150
Ancho/Wide	65



Referencia/Reference	AD-003-12
Material/Material	■ 16
Alto/High	160
Ancho/Wide	70



Referencia/Reference	AD-002-12
Material/Material	■ 14
Alto/High	150
Ancho/Wide	65



Referencia/Reference	AD-004-12
Material/Material	■ 20
Alto/High	210
Ancho/Wide	90



AD-102-19	AD-103-19	AD-104-19	Referencia/Reference	AD-105-19	AD-106-19	AD-107-19
■ 24	■ 28	■ 40	Material/Material	■ 21	■ 24	■ 30
200	200	340	Alto/High	210	210	210
95	95	160	Ancho/Wide	90	90	125

RECUERDE: FABRICAMOS OTRAS MEDIDAS BAJO PEDIDO

REMEMBER: WE PRODUCE OTHER MEASURES UNDER ORDER

Referencia/Reference	AD-005-12
Material/Material	■ 8, 12, 14
Alto/High	350
Ancho/Wide	130



Liso /Plane



LAS LONGITUDES EXPRESADAS SON APROXIMADAS

LENGTHS EXPRESSED ARE APPROXIMATE



Referencia/Reference	AD-034-16
Material/Material	■ ÷ 25
Alto/High	730
Ancho/Wide	205

Referencia/Reference	AD-035-16
Material/Material	■ ÷ 14
Alto/High	450
Ancho/Wide	130



AD-036-16	Referencia/Reference	AD-038-16
■ ÷ 14	Material/Material	■ ÷ 16
450	Alto/High	400
130	Ancho/Wide	140



AD-037-16	Referencia/Reference	AD-039-16
■ ÷ 14	Material/Material	■ ÷ 16
400	Alto/High	450
140	Ancho/Wide	135



**RECUERDE: FABRICAMOS OTRAS
MEDIDAS BAJO PEDIDO**
**REMEMBER: WE PRODUCE OTHER
MEASURES UNDER ORDER**

Referencia/Reference	AD-165-25
Material/Material	■ 12, 14, 16, 20, 25, 30
Alto/High	900 / 700
Ancho/Wide	250

Torsionado / Twisted

Liso / Plane



Martilleado
en los cantos
/ Hammered
on edges



Referencia/Reference	AD-040-17
Material/Material	■ 12, 14, 16, 20, 25, 30
Alto/High	900 / 700
Ancho/Wide	250

Referencia/Reference	AD-166-25
Material/Material	■ 12, 14, 16, 20, 25, 30
Alto/High	900 / 700
Ancho/Wide	250



AD-155-24	AD-157-24	Referencia/Reference	AD-158-24	AD-159-24
■ 20, 25, 30	■ 20	Material/Material	■ 20	■ 20
560	500	Alto/High	500	500
170	140	Ancho/Wide	140	140



Referencia/Reference	AD-010-13	AD-011-13	AD-012-13	AD-013-13	AD-014-13	AD-015-13
Material/Material	- 12x6, 14x5, 16x6	- 12x6, 14x5, 16x6	- 12x6, 14x5, 16x6	- 12x6, 14x5, 16x6	- 12x6, 14x5, 16x6	- 12x6, 14x5, 16x6
Alto/High	465	420	365	320	270	215
Ancho/Wide	115	115	115	115	115	90



AD-122-21	Referencia/Reference	AD-023-14
- 12x6, 14x5	Material/Material	- 12x6, 14x5, 16x6
400	Alto/High	360
150	Ancho/Wide	125



RECUERDE: FABRICAMOS OTRAS MEDIDAS BAJO PEDIDO
REMEMBER: WE PRODUCE OTHER MEASURES UNDER ORDER



Referencia/Reference	AD-024-14	AD-025-14	AD-026-14	AD-027-14
Material/Material	- 12x6, 14x5, 16x6	- 12x6, 14x5, 16x6	- 12x6, 14x5, 16x6	- 12x6, 14x5, 16x6
Alto/High	360	290	220	150
Ancho/Wide	130	130	130	70

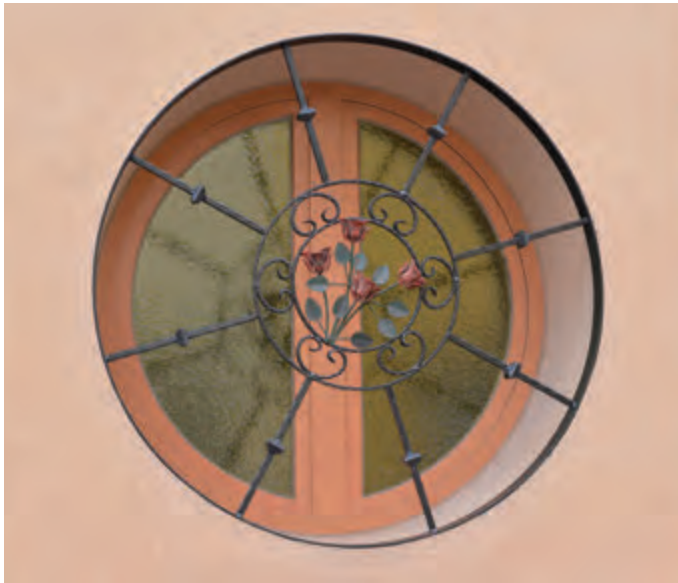

Fabricación con forja
Forging Manufacturing



Aplicación de artículos de forja / Application of forging items



Fabricado con pletina / Manufactured with flat bar
12x6, 14x5, 16x6



Referencia/Reference	AD-028-15	AD-029-15	AD-030-15	AD-032-15	AD-033-15
Material/Material	- 12x6, 14x5, 16x6	- 12x6, 14x5, 16x6	- 12x6, 14x5, 16x6	- 12x6, 14x5, 16x6	- 12x6, 14x5, 16x6
Alto/High	95	120	150	180	115
Ancho/Wide	60	70	85	58	55

LAS LONGITUDES EXPRESADAS SON APROXIMADAS
LENGTHS EXPRESSED ARE APPROXIMATE



Referencia/Reference	AD-041-17	AD-042-17	AD-043-17
Material/Material	- 12x6, 14x5, 16x6	- 12x6, 14x5, 16x6	- 12x6, 14x5, 16x6
Alto/High	105	125	130
Ancho/Wide	65	80	90



Referencia/Reference	AD-125-22	AD-126-22	AD-127-22	AD-128-22	AD-129-22
Material/Material	- 12x6, 14x5	- 12x6, 14x5	- 12x6, 14x5	- 12x6, 14x5	- 12x6, 14x5
Alto/High	150	185	270	200	115
Ancho/Wide	90	115	115	85	60

Embelledor para cierres Decorations for locks



AD-091-19	Referencia/Reference	AD-092-19
Chapa estampada/ Stamped sheet	Material/Material	Chapa estampada/ Stamped sheet
293	Alto/High	293
112	Ancho/Wide	112

Adornos para cuadro pasante Decorations for interior squares



Referencia/Reference	AD-093-19	AD-094-19	AD-095-19
Material/Material	Interior ■ 25, ■ 30	Interior ■ 20, ■ 25	Interior ■ 16, ■ 20
Alto/High	110	90	70
Ancho/Wide	110	90	70

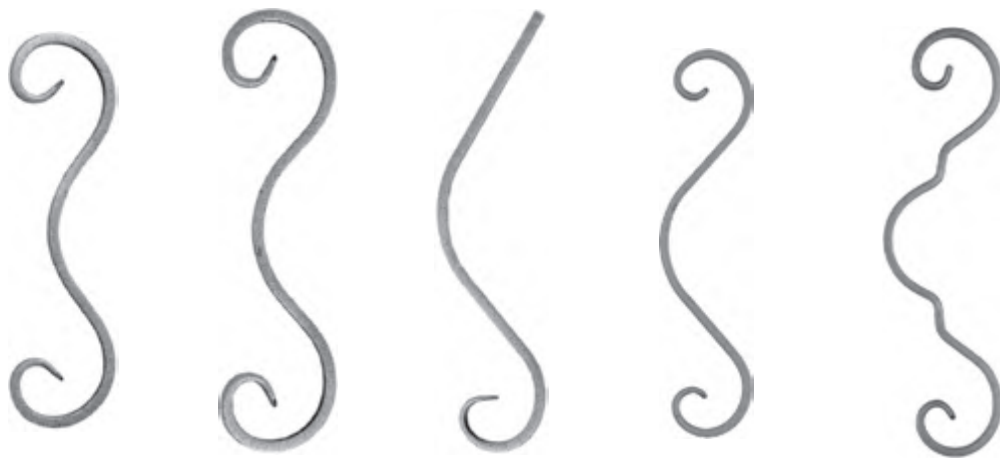

Referencia/Reference	AD-118-21	AD-119-21	AD-120-21	AD-021-14	AD-022-14
Material/Material	- 14x5	- 14x5	- 12x6, 14x5, 16x6	- 12x6, 14x5, 16x6	- 12x6, 14x5, 16x6
Alto/High	190	210	210	235	260
Ancho/Wide	53	55	60	55	75

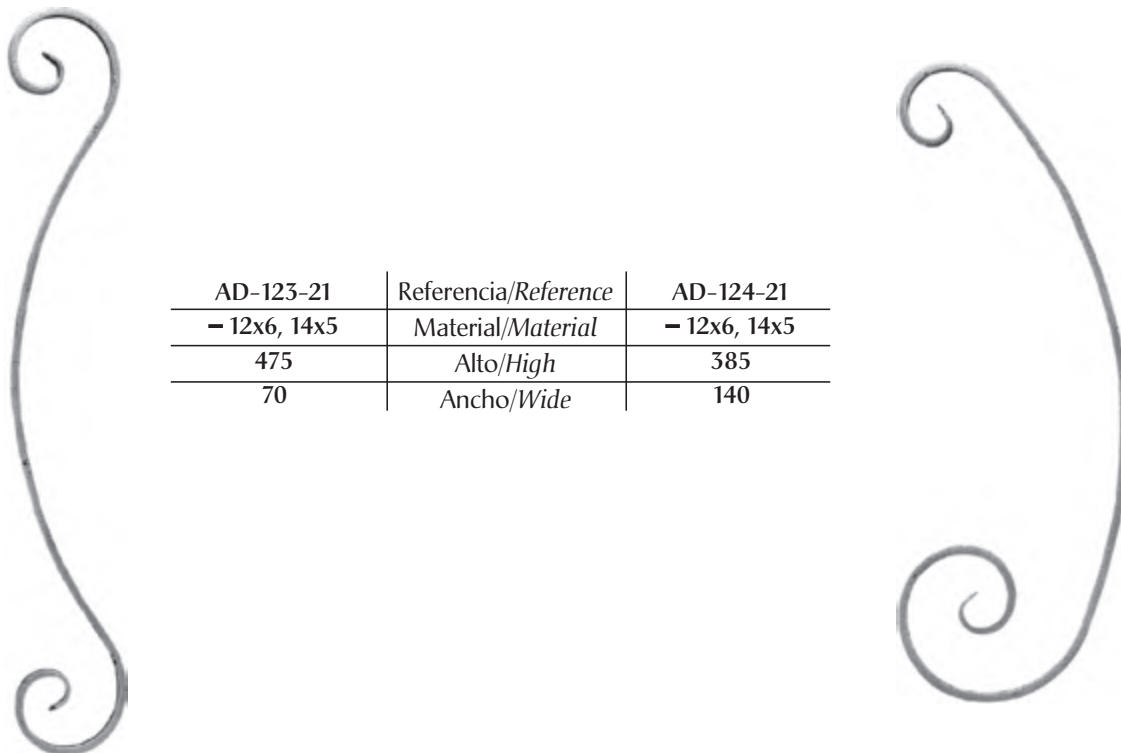

AD-123-21	Referencia/Reference	AD-124-21
- 12x6, 14x5	Material/Material	- 12x6, 14x5
475	Alto/High	385
70	Ancho/Wide	140

RECUERDE: FABRICAMOS OTRAS MEDIDAS BAJO PEDIDO
REMEMBER: WE PRODUCE OTHER MEASURES UNDER ORDER



Martilleado
/Hammered



Referencia/Reference	AD-133-23	AD-134-23	AD-135-23	AD-136-23
Material/Material	- 14x5	- 14x5	- 14x5	- 14x5
Alto/High	360	365	320	270
Ancho/Wide	130	115	115	115



Martilleado
/Hammered

Referencia/Reference	AD-137-23	AD-138-23	AD-139-23
Material/Material	- 14x5	- 14x5	- 14x5
Alto/High	235	210	193
Ancho/Wide	55	55	55



Referencia/Reference	AD-141-23	AD-142-23	AD-143-23	AD-144-23
Material/Material	- 14x5	- 14x5	- 14x5	- 14x5
Alto/High	120	145	125	100
Ancho/Wide	70	95	80	68



Referencia/Reference	AD-018-14	AD-018 I -14	AD-019-14
Material/Material	- 14x5	- 14x5	- 14x5
Alto/High	120	120	197
Ancho/Wide	240	120	120



Martilleado
/Hammered



AD-114A-20	Referencia/Reference	AD-114B-20
- 14x5	Material/Material	- 14x5
185	Alto/High	185
120	Ancho/Wide	120

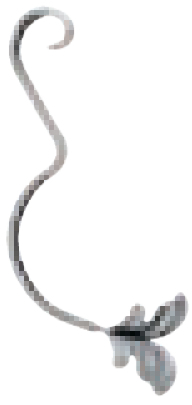

AD-115A-20	Referencia/Reference	AD-115B-20
- 12x6, 14x5	Material/Material	- 12x6, 14x5
200	Alto/High	200
40	Ancho/Wide	40

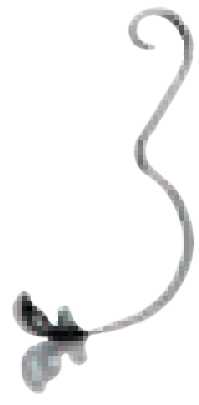

Referencia/Reference	AD-116X-20	AD-117A-20	AD-117B-20
Material/Material	- 12x6, 14x5, 16x6	- 12x6, 14x5, 16x6	- 12x6, 14x5, 16x6
Alto/High	500	500	500
Ancho/Wide	95	95	95



AD-006-12 Izq.	Referencia/Reference
Chapa estampada/ Stamped sheet	Material/Material
105 ÷ 110	Alto/High
39 ÷ 40	Ancho/Wide



AD-007-12 Derch.	Referencia/Reference
Chapa estampada/ Stamped sheet	Material/Material
105 ÷ 110	Alto/High
39 ÷ 40	Ancho/Wide



AD-008-12 Izq.	Referencia/Reference
Chapa estampada/ Stamped sheet	Material/Material
60 ÷ 64	Alto/High
68 ÷ 72	Ancho/Wide



AD-009-12 Derch.	Referencia/Reference
Chapa estampada/ Stamped sheet	Material/Material
60 ÷ 64	Alto/High
68 ÷ 72	Ancho/Wide



Referencia/Reference	AD-061-18
Material/Material	Chapa estampada/ Stamped sheet
Alto/High	150
Ancho/Wide	80



AD-066-18	Referencia/Reference
Chapa estampada/ Stamped sheet	Material/Material
170	Alto/High
200	Ancho/Wide



AD-067-18	Referencia/Reference
Chapa estampada/ Stamped sheet	Material/Material
170	Alto/High
200	Ancho/Wide



AD-070-18	Referencia/Reference
Chapa estampada/ Stamped sheet	Material/Material
110	Alto/High
100	Ancho/Wide



AD-071-18	Referencia/Reference
Chapa estampada/ Stamped sheet	Material/Material
110	Alto/High
100	Ancho/Wide



AD-074-18	Referencia/Reference
Chapa estampada/ Stamped sheet	Material/Material
100	Alto/High
60	Ancho/Wide



AD-075-18	Referencia/Reference
Chapa estampada/ Stamped sheet	Material/Material
100	Alto/High
60	Ancho/Wide



AD-076-18	Referencia/Reference
Chapa estampada/ Stamped sheet	Material/Material
118	Alto/High
63	Ancho/Wide



AD-077-18	Referencia/Reference
Chapa estampada/ Stamped sheet	Material/Material
118	Alto/High
63	Ancho/Wide



AD-081-18	Referencia/Reference
Chapa estampada/ Stamped sheet	Material/Material
165	Alto/High
60	Ancho/Wide



AD-082-18	Referencia/Reference
Chapa estampada/ Stamped sheet	Material/Material
165	Alto/High
60	Ancho/Wide



AD-083-18	Referencia/Reference
Chapa estampada/ Stamped sheet	Material/Material
102	Alto/High
65	Ancho/Wide



AD-084-18	Referencia/Reference
Chapa estampada/ Stamped sheet	Material/Material
102	Alto/High
65	Ancho/Wide



Referencia/Reference	AD-085-18
Material/Material	Chapa estampada/ Stamped sheet
Diametro/Diameter	90

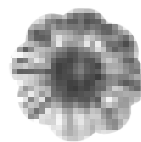

AD-086-18	Referencia/Reference
Chapa estampada/ Stamped sheet	Material/Material
65	Diametro/Diameter



AD-087-18	Referencia/Reference
Chapa estampada/ Stamped sheet	Material/Material
60	Diametro/Diameter



Referencia/Reference	AD-145-24
Material/Material	■ 12
Alto/High	900
Ancho/Wide	250



Referencia/Reference	AD-146-24
Material/Material	- 14x5, 16x6
Alto/High	870
Ancho/Wide	360



Referencia/Reference	AD-147-24
Material/Material	- 14x5, 16x6
Alto/High	150
Ancho/Wide	265



Referencia/Reference	AD-121-21
Material/Material	- 12x6, 14x5
Alto/High	400
Ancho/Wide	150



AD-016-13
- 12x6, 14x5
870
360

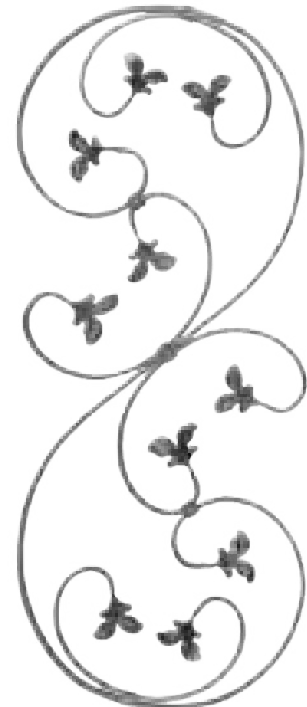

Referencia/Reference	AD-195-25/E
Material/Material	- 12x6, 14x5
Alto/High	870
Ancho/Wide	360



Referencia/Reference	AD-017-13
Material/Material	- 12x6, 14x5
Alto/High	155
Ancho/Wide	260



NUESTROS TRABAJOS/OUR IRON WORKS



Ejemplos prácticos de aplicaciones de forja
Practical samples the applications forging



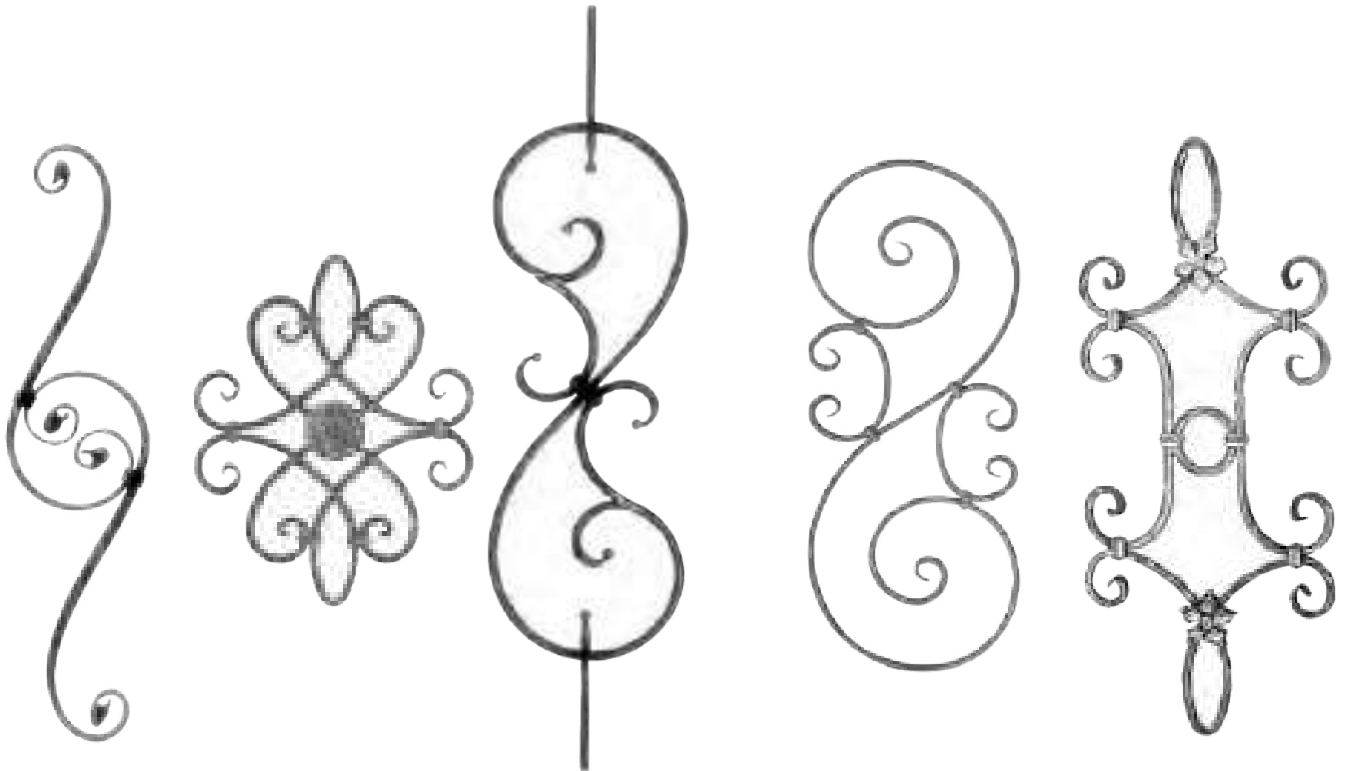

AD-168-25/A	AD-169-25/A	AD-170-25/A	Referencia/Reference	AD-171-25/A	AD-172-25/A
■ 16 ÷ 10	■ 12	● 12	Material/Material	● 14	■ 12
810	530	1000	Alto/High	900	800
160	410	260	Ancho/Wide	340	385

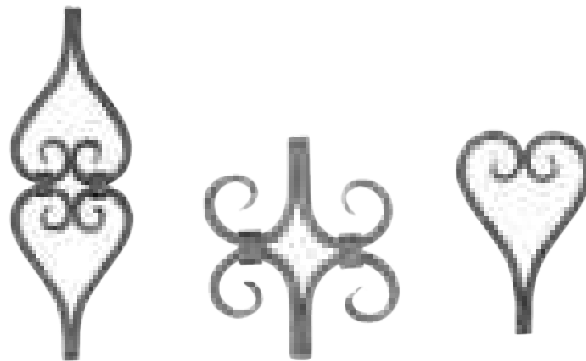

Referencia/Reference	AD-173-25/A	AD-174-25/A	AD-175-25/A
Material/Material	- 16x8 para ■ 16	- 16x8 para ■ 16	- 16x8 para ■ 16
Alto/High	360	150	180
Ancho/Wide	120	130	120



Plano / Plain

AD-176-25/A	Referencia/Reference	AD-178-25/A
■ 16	Material/Material	■ 16
200	Alto/High	200
200	Ancho/Wide	200



Vertice / Vertex



AD-179-25/B	Referencia/Reference	AD-180-25/B
● 12	Material/Material	● 12
380	Alto/High	380
330	Ancho/Wide	330



AD-181-25/B	Referencia/Reference	AD-182-25/B
● 12	Material/Material	● 12
620	Alto/High	620
410	Ancho/Wide	410



**LAS LONGITUDES EXPRESADAS
SON APROXIMADAS**

**LENGTHS EXPRESSED
ARE APPROXIMATE**



AD-183-25/B	Referencia/Reference	AD-184-25/B
● 12	Material/Material	● 12
970	Alto/High	970
420	Ancho/Wide	420





Referencia/Reference	AD-185-25/C
Material/Material	● 12
Alto/High	970
Ancho/Wide	780



Referencia/Reference	AD-186-25/C
Material/Material	● 12
Alto/High	970
Ancho/Wide	780



Referencia/Reference	AD-187-25/C
Material/Material	● 12
Alto/High	880
Ancho/Wide	800



Referencia/Reference	AD-188-25/C
Material/Material	● 12
Alto/High	880
Ancho/Wide	800



Referencia/Reference	AD-189-25/D
Material/Material	- 16x8
Alto/High	710
Ancho/Wide	650



Referencia/Reference	AD-191-25/D
Material/Material	● 14
Alto/High	950
Ancho/Wide	215



Referencia/Reference	AD-190-25/D
Material/Material	● 6
Alto/High	410
Ancho/Wide	470



AD-130-22	Referencia/Reference	AD-131-22
- 12x6, 14x5	Material/Material	- 12x6, 14x5
100	Diametro/Diameter	120



Referencia/Reference	AD-108-19	AD-109-19	AD-111-19	AD-112-19	AD-198-19	AD-199-19	AD-200-19	AD-201-19
Material/Material	- 12x6, 16x6	- 12x6, 14x5	- 12x6, 14x5	- 12x6, 14x5	■ 12x12	■ 14x14	■ 12x12	■ 14x14
Diametro/Diameter	110	130	100	120	115	115	105	105



Referencia/Reference	AD-192-25/E
Material/Material	- 14x5
Alto/High	900
Ancho/Wide	265

Referencia/Reference	AD-193-25/E
Material/Material	- 14x5
Alto/High	900
Ancho/Wide	265

Referencia/Reference	AD-194-25/E
Material/Material	- 14x5
Alto/High	900
Ancho/Wide	390

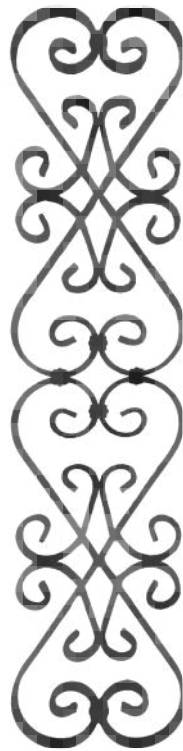

Nuevo modelo
New model

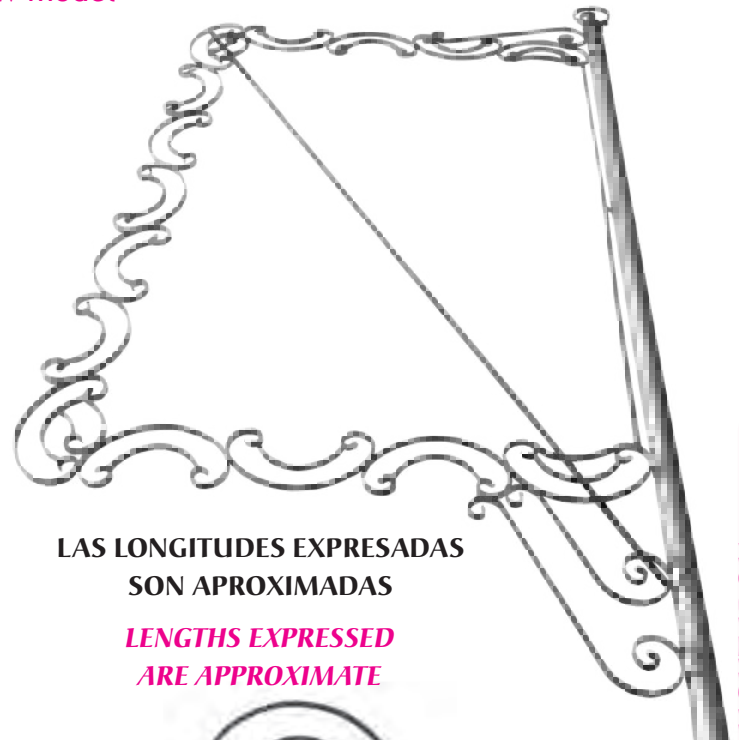

LAS LONGITUDES EXPRESADAS
SON APROXIMADAS

LENGTHS EXPRESSED
ARE APPROXIMATE

AD-196-25/E	Referencia/Reference	AD-198-25/E
- 14x5	Material/Material	- 14x5
775	Alto/High	800
140	Ancho/Wide	180

Referencia/Reference	AD-197-25/E
Material/Material	- 14x5
Alto/High	520
Ancho/Wide	265





AR-C-1-26	AR-C-2-26	Referencia/Reference	AR-001-26	AR-002-26	AR-003-26
■ 30	■ 30	Material/Material	■ 30	■ 25 ÷ 20	■ 25, ■ 30
1200	1100	Alto/High	1200	1200	1200
-	-	Ancho/Wide	125	-	-



AR-004-27	AR-005-27	Referencia/Reference	AR-006-27	AR-008-27	AR-012-27
■ 25, ■ 30	■ 25	Material/Material	■ 25	■ 30 ÷ 25	■ 40
1200	1200	Alto/High	1200	1200	1200
-	-	Ancho/Wide	-	-	160

Retorcido desigual; fabricación artesanal.

Alternative twisting; artistic forging.

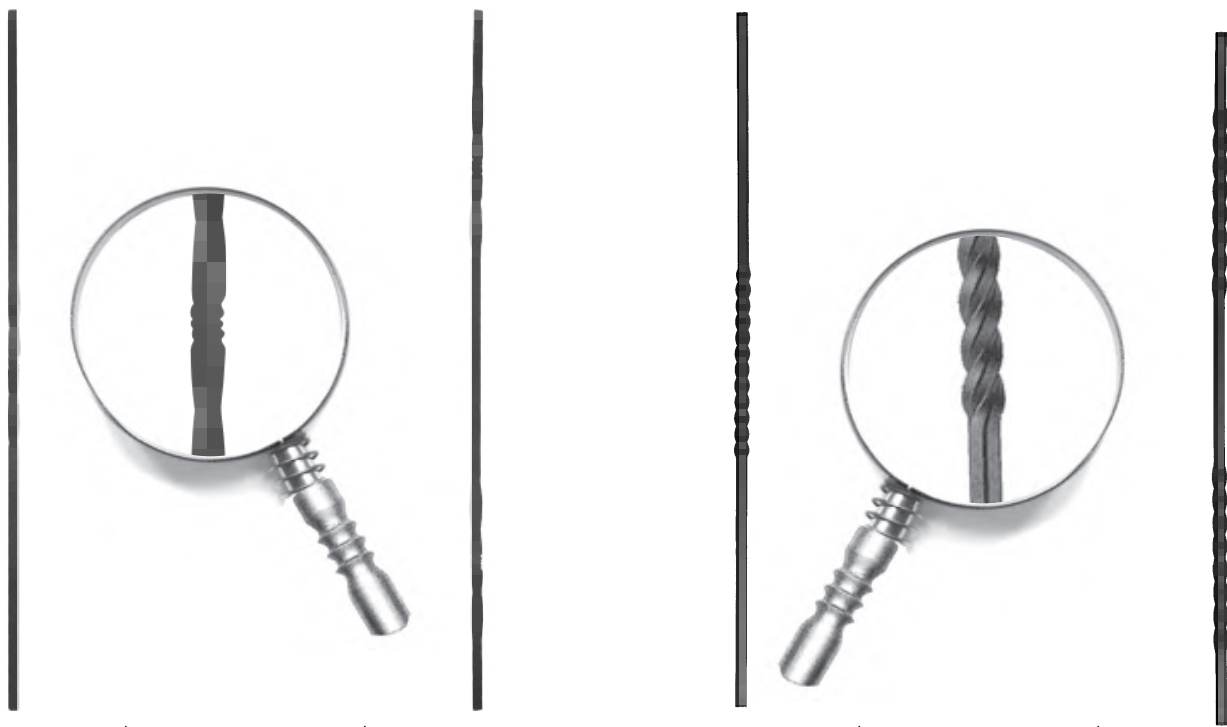

BA-109-35/D	Referencia/Reference	BA-110-35/D
■ 14, 16	Material/Material	■ 14, 16
900/1000...	Alto/High	900/1000...

BA-017-29	Referencia/Reference	BA-018-29
■ 12, 14	Material/Material	■ 12, 14
900/1000...	Alto/High	900/1000...

BAJO PEDIDO, SE FABRICAN ESTOS RETORCIDOS EN PLETINAS

UNDER ORDER WE CAN PRODUCE THOSE TWISTING WITH FLAR BARS



Retorcidos alternos

Alternate twisting

BA-001-28	BA-002-28	BA-003-28	BA-129-35	Referencia/Reference	BA-064-34	BA-065-34
■ 12, 14, 16	■ 12, 14, 16	■ 12, 14, 16	■ 14	Material/Material	■ 12, 14	■ 12, 14
900/1000...	900/1000...	900/1000...	900	Alto/High	900	900



BA-004-28	BA-005-28	Referencia/Reference	BA-007-28	BA-008-28
■ 12, 14	■ 12, 14	Material/Material	■ 12, 14	■ 12, 14
900	900	Alto/High	900	900
165	165	Ancho/Wide	160	160

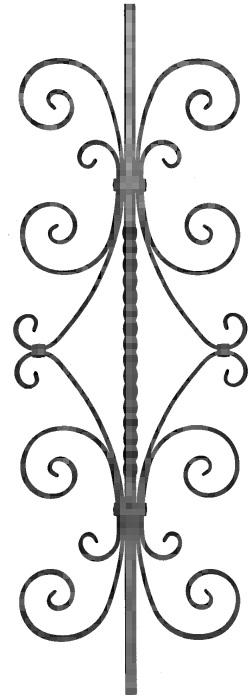
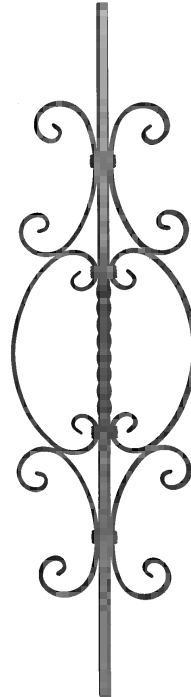
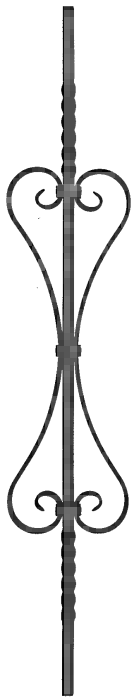

BA-009-28	BA-010-29	Referencia/Reference	BA-011-29	BA-012-29
■ 12, 14	■ 12, 14	Material/Material	■ 12, 14	■ 12, 14
900	900	Alto/High	900	900
160	170	Ancho/Wide	240	300

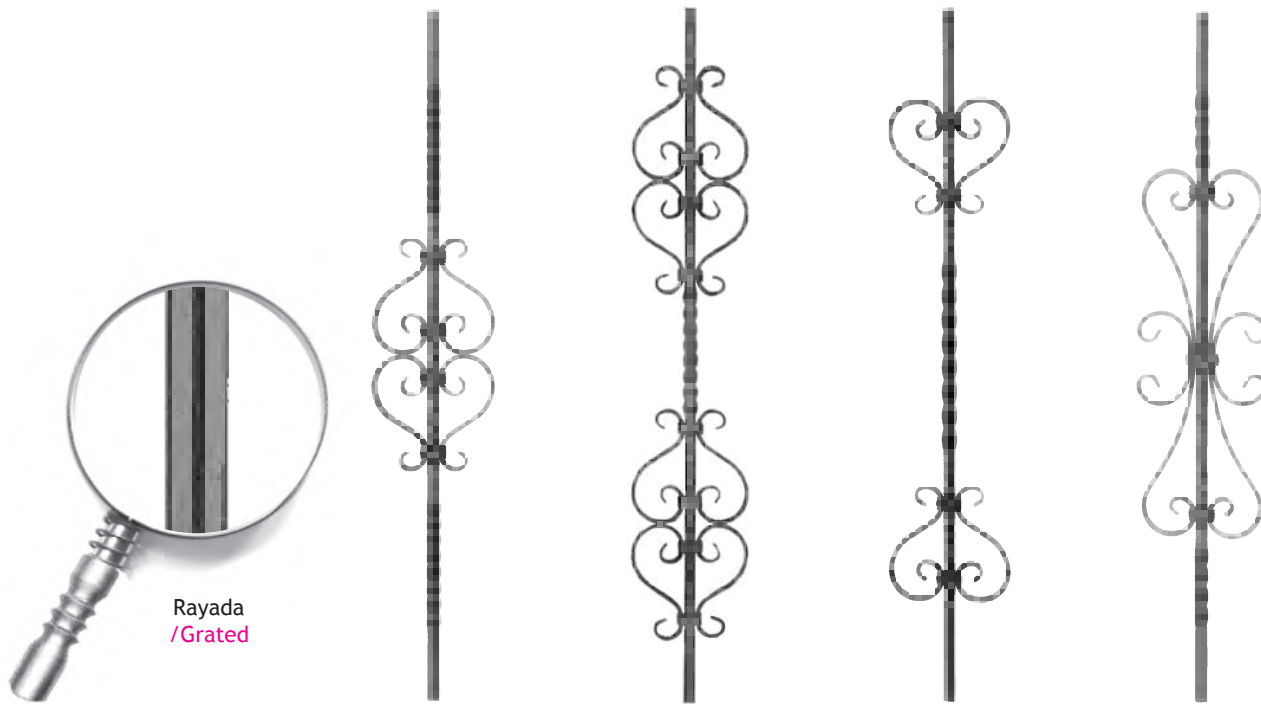

Referencia/Reference	BA-021-35	BA-102-35	BA-022-35	BA-023-30
Material/Material	■ 12, 14	■ 12, 14	■ 12, 14	■ 12, 14
Alto/High	900	900	900	900
Ancho/Wide	155	155	155	170

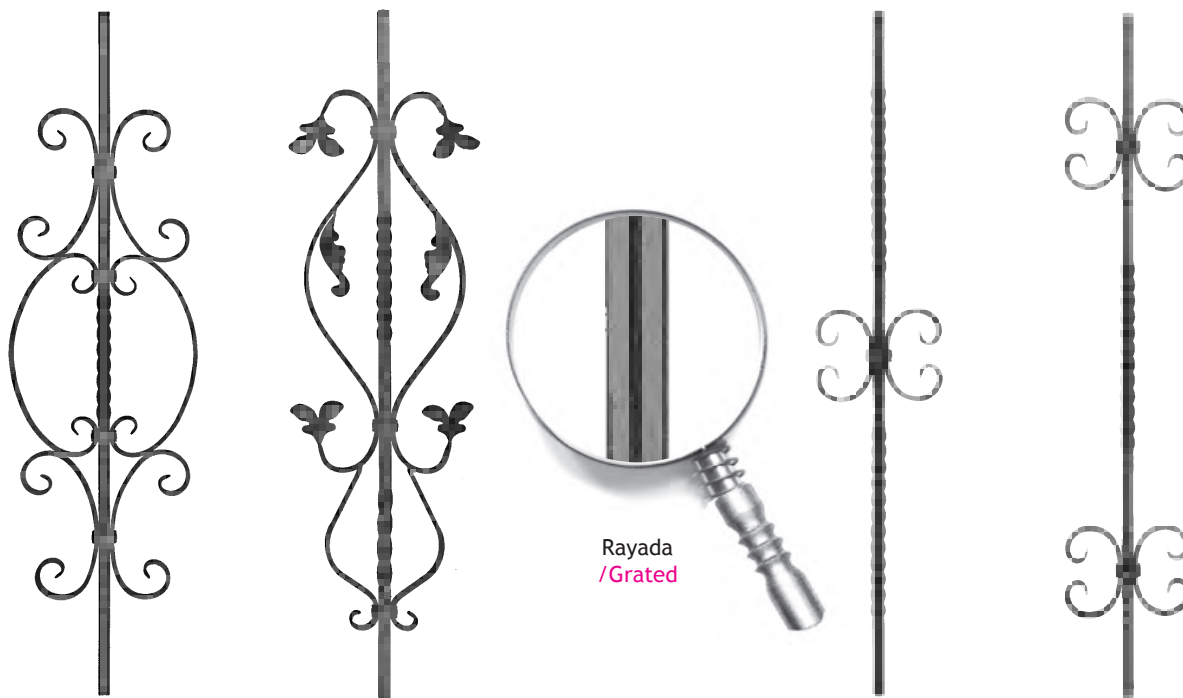

BA-024-30	BA-027-30	Referencia/Reference	BA-019-30	BA-020-30
■ 14	■ 12, 14, 16	Material/Material	■ 12, 14	■ 12, 14
900	900	Alto/High	900	900
240	250	Ancho/Wide	165	165

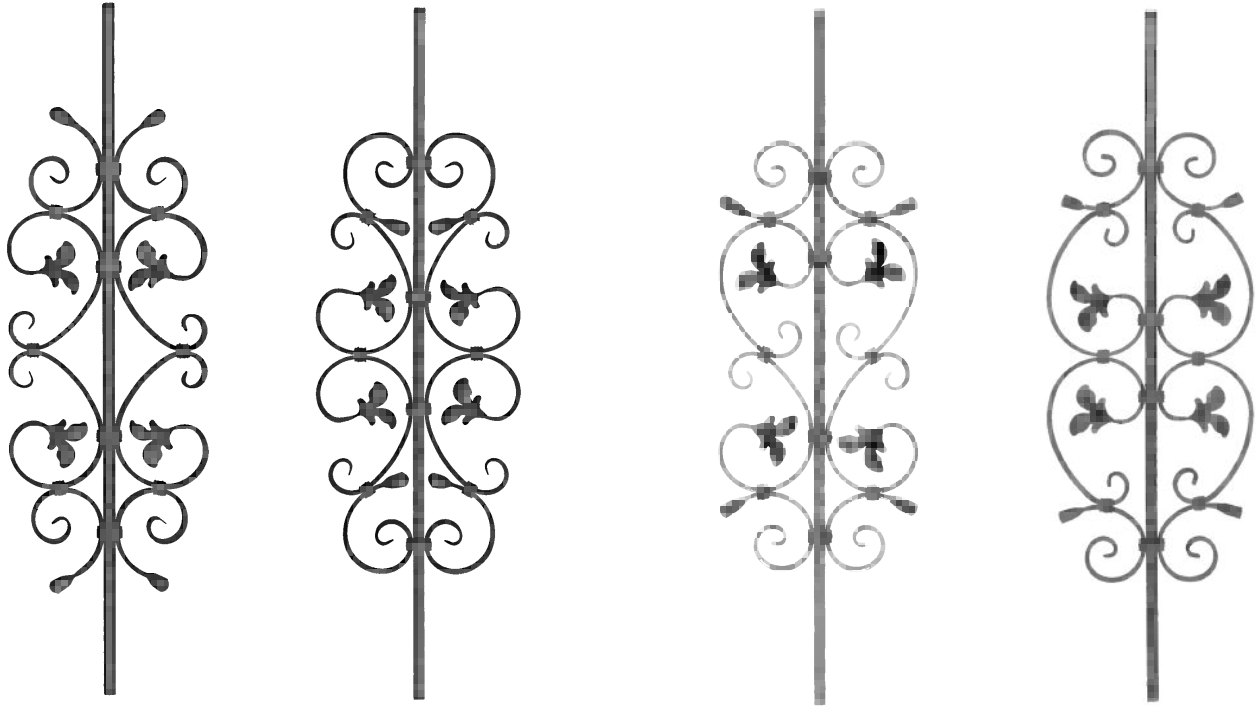

BA-035-31	BA-036-31	Referencia/Reference	BA-037-31	BA-038-31
■ 12 Martilleada Canto/ Hammered on edges	■ 14 Martilleada Canto/ Hammered on edges	Material/Material	■ 14 Martilleada Canto/ Hammered on edges	■ 14 Martilleada Canto/ Hammered on edges
900	900	Alto/High	900	900
255	265	Ancho/Wide	255	265



Referencia/Reference	BA-040-32	BA-041-32	BA-046-32	BA-047-32	BA-048-32
Material/Material	■ 14 Martilleada Canto/ Hammered on edges	■ 14 Martilleada Canto/ Hammered on edges	■ 12 ÷ 14 ÷ 16 Martilleada Canto/ Hammered on edges	■ 14 Martilleada Canto/ Hammered on edges	■ 14 Martilleada Canto/ Hammered on edges
Alto/High	900	900	1000	1000	1000
Ancho/Wide	105	105	-	-	-

LAS LONGITUDES EXPRESADAS
SON APROXIMADAS

LENGTHS EXPRESSED
ARE APPROXIMATE



BA-050-33	BA-051-33	Referencia/Reference	BA-052-33	BA-053-33
■ 12 ÷ 14 Martilleada/ Hammered	■ 12 ÷ 14 Martilleada/ Hammered	Material/Material	■ 12 ÷ 14 Martilleada/ Hammered	■ 14 Martilleada/ Hammered
1000	1000	Alto/High	1000	900
-	-	Ancho/Wide	-	31

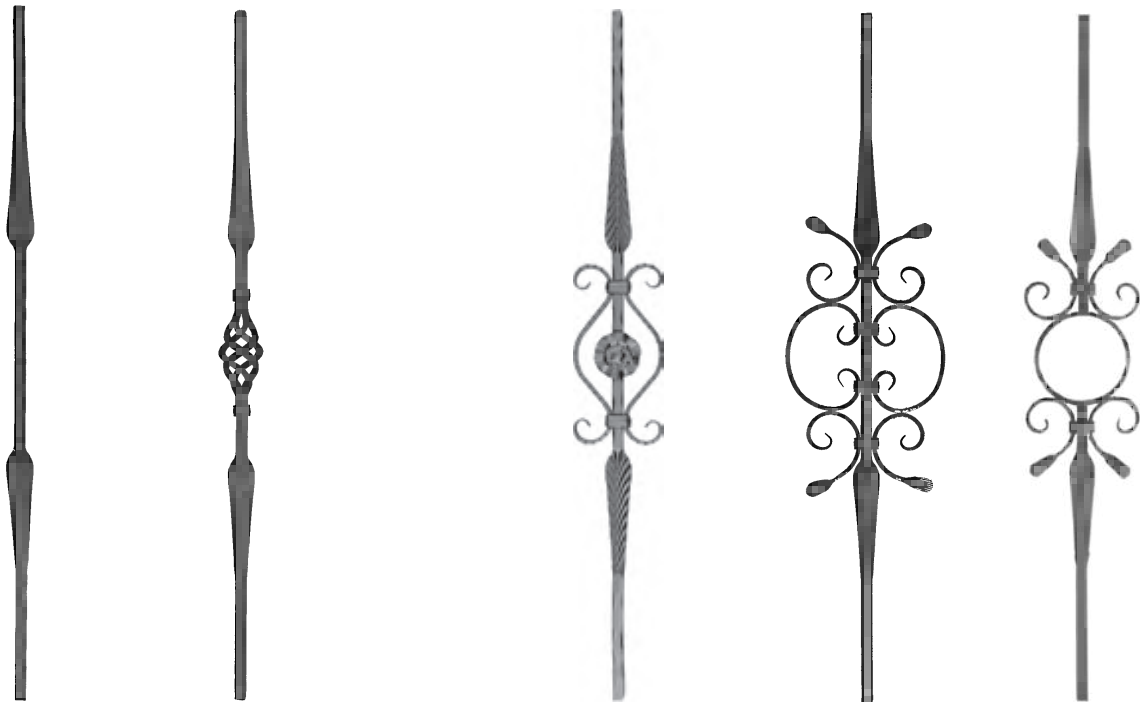

BA-054-33	BA-055-33	Referencia/Reference	BA-058-33	BA-059-33	BA-103-35
■ 14 Martilleada/ Hammered	■ 14 Martilleada/ Hammered	Material/Material	■ 14 Martilleada/ Hammered	■ 14 Martilleada/ Hammered	■ 14 Martilleada/ Hammered
900	900	Alto/High	900	900	900
35	65	Ancho/Wide	110	210	150



BA-078-35	BA-079-35	BA-121-35	Referencia/Reference	BA-122-35	BA-123-35	BA-124-35
■ 14	■ 14	■ 14	Material/Material	■ 14	■ 14	■ 14
900	900	1000	Alto/High	1000	1000	1000

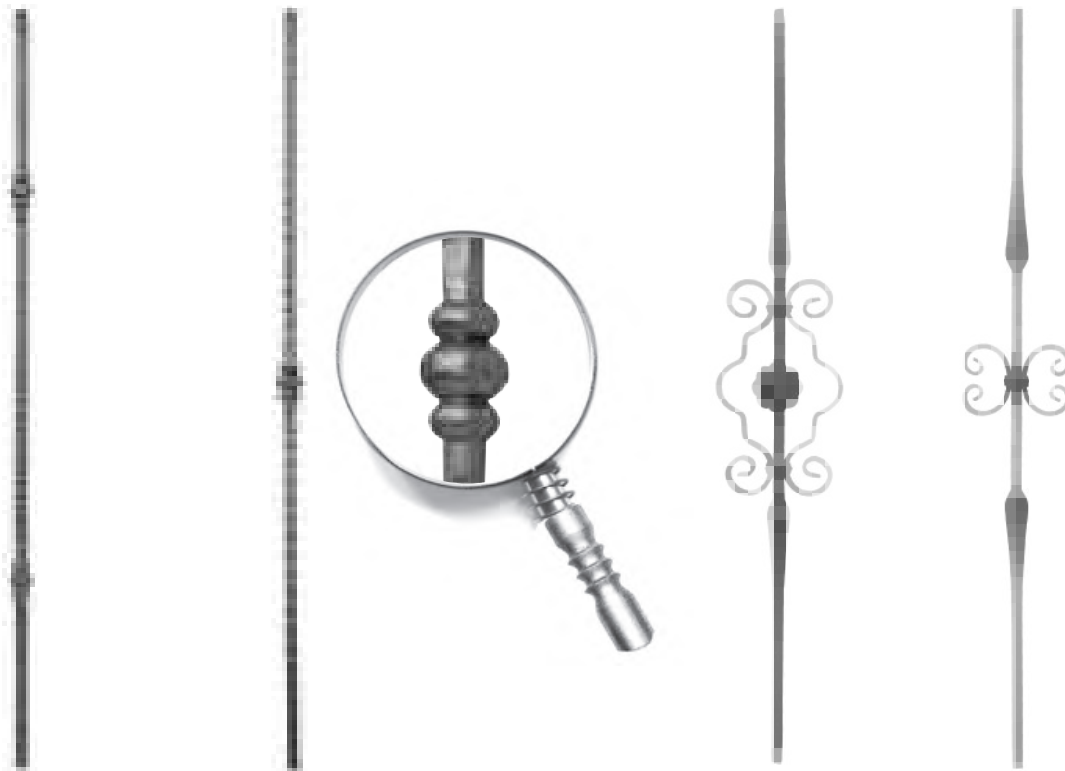

BA-125-35	BA-126-35	Referencia/Reference	BA-127-35	BA-128-35
■ 12	■ 12	Material/Material	■ 14	■ 14
1000	1000	Alto/High	1000	1000
-	-	Ancho/Wide	175	145

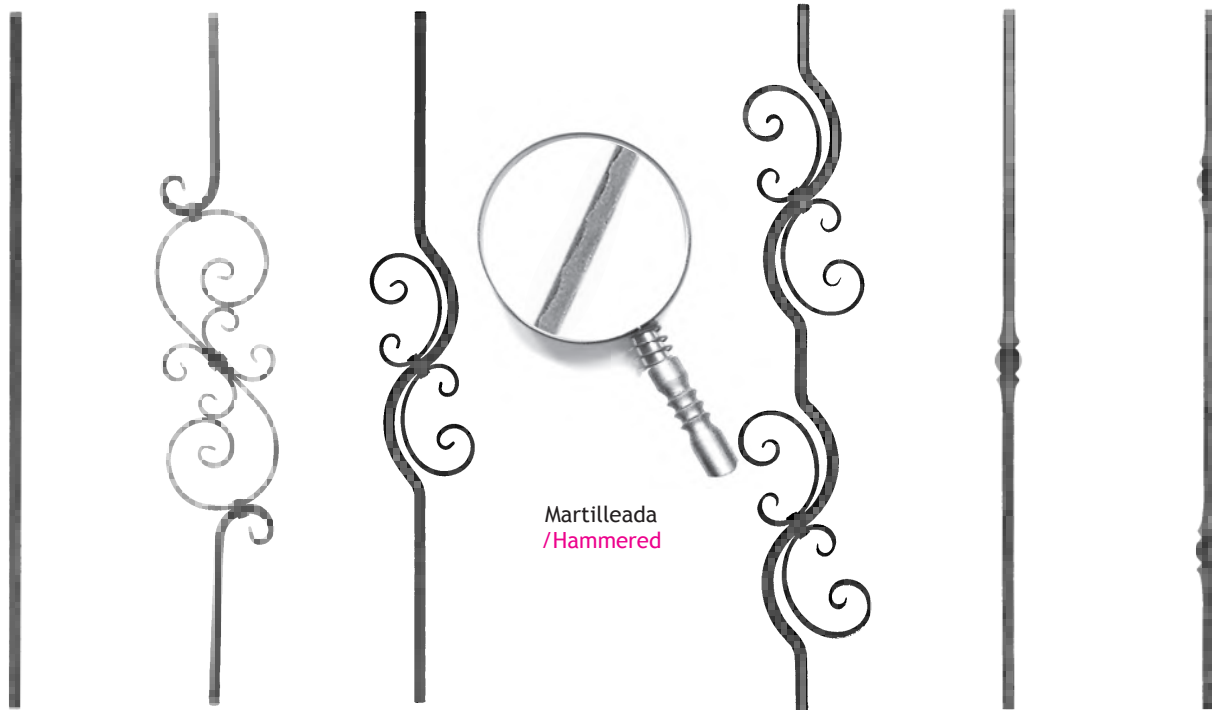

BA-028-30	BA-029-30	BA-030-30	Referencia/Reference	BA-031-30	BA-039-31	BA-039D-31
■ 12, 14, 16, 20... Martilleada Canto/ Hammered on edges	■ 12, 14 Martilleada Canto/ Hammered on edges	■ 12, 14 Martilleada Canto/ Hammered on edges	Material/Material	■ 12, 14 Martilleada Canto/ Hammered on edges	■ 12, 14 Martilleada Canto/ Hammered on edges	■ 12, 14 Martilleada Canto/ Hammered on edges
900/1000...	900	900	Alto/High	900	900	900
-	155	150	Ancho/Wide	150	34	34

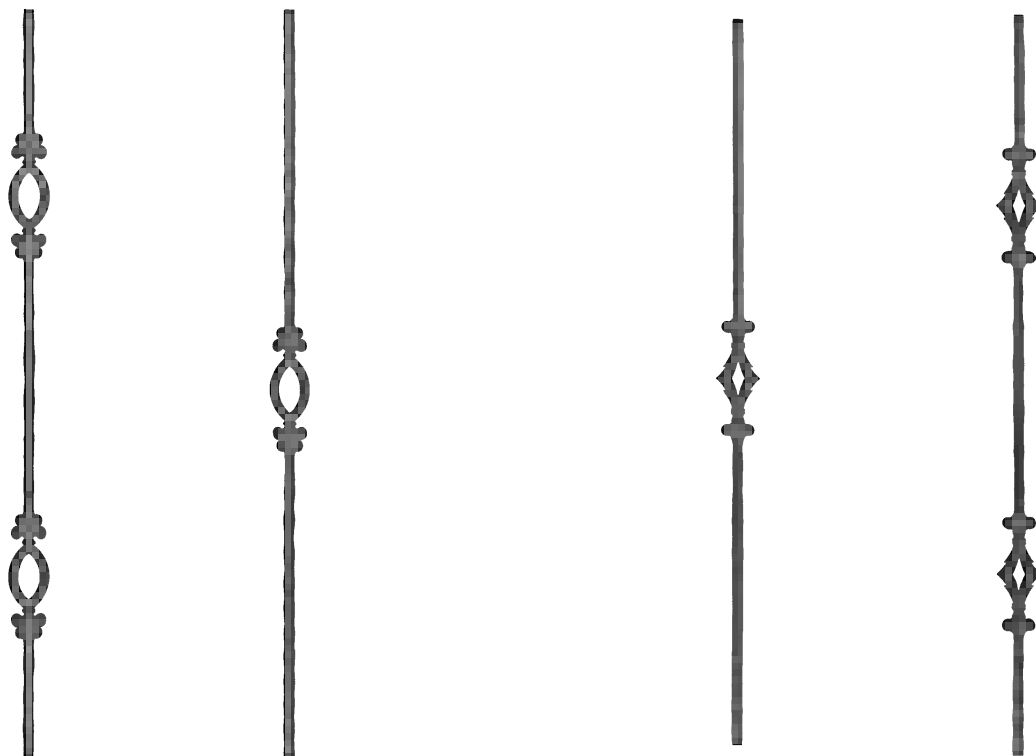

BA-060-34	BA-061-34	Referencia/Reference	BA-062-34	BA-063-34
■ 14 Martilleada/ Hammered	■ 14 Martilleada/ Hammered	Material/Material	■ 14 Martilleada/ Hammered	■ 14 Martilleada/ Hammered
1000	1000	Alto/High	1000	1000

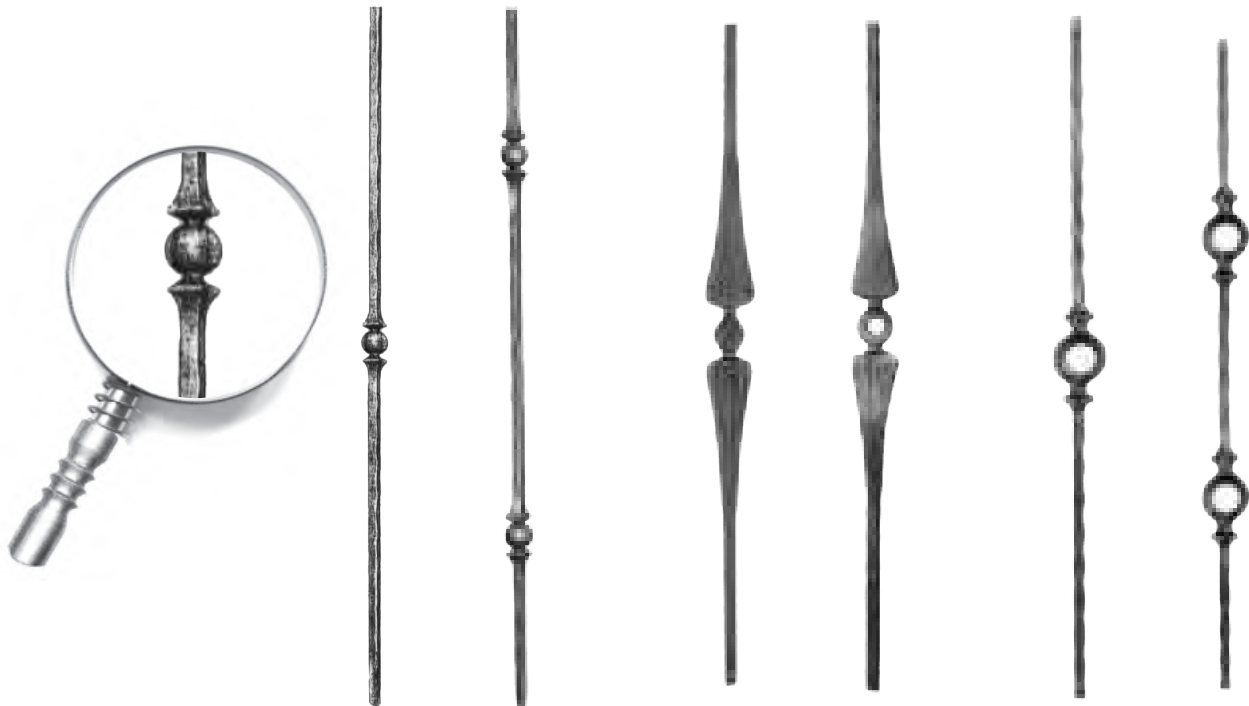

Referencia/Reference	BA-082-35/A - BA-083-35/A	BA-084-35/A - BA-085-35/A	BA-086-35/A - BA-087-35/A
Material/Material	■ 12 ÷ 13,5 Martilleada/ Hammered	■ 14 Martilleada/ Hammered	■ 14 Martilleada/ Hammered
Alto/High	1000	1000	1000

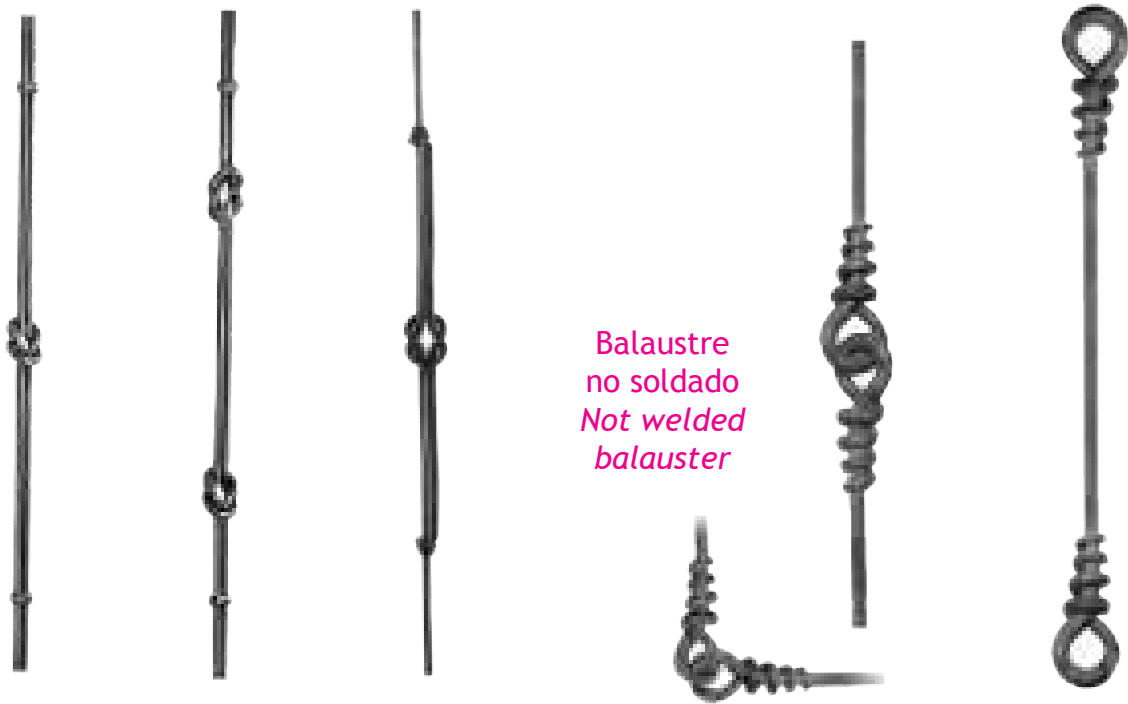

BA-088-35/A	BA-089-35/A	BA-090-35/A	Referencia/Reference	BA-091-35/A	BA-092-35/A
● 12	● 12	● 12	Material/Material	● 12	● 12
1000	1000	1000	Alto/High	1000	900
-	-	-	Observaciones/Remarks	No soldado/Not welded	-



BA-093-35/B	BA-094-35/B	Referencia/Reference	BA-095-35/B	BA-096-35/B
■ 14 Martilleada/ Hammered	■ 14 Martilleada/ Hammered	Material/Material	■ 14 Martilleada/ Hammered	■ 14 Martilleada/ Hammered
900	900	Alto/High	900	900
130	130	Ancho/Wide	130	130



BA-097-35/B	BA-098-35/B	Referencia/Reference	BA-099-35/B	BA-100-35/B
■ 14 Martilleada/ Hammered	■ 14 Martilleada/ Hammered	Material/Material	■ 14 Martilleada/ Hammered	■ 14 Martilleada/ Hammered
900	900	Alto/High	900	900
130	130	Ancho/Wide	130	130



BA-101-35/C	BA-102-35/C	Referencia/Reference	BA-103-35/C	BA-104-35/C
■ 14	■ 14	Material/Material	■ 14	■ 14
900	900	Alto/High	900	900
130	130	Ancho/Wide	130	130

LAS LONGITUDES EXPRESADAS
SON APROXIMADAS

LENGTHS EXPRESSED
ARE APPROXIMATE



BA-105-35/C	BA-106-35/C	Referencia/Reference	BA-107-35/C	BA-108-35/C
■ 14	■ 14	Material/Material	■ 14	■ 14
900	900	Alto/High	900	900
160	150	Ancho/Wide	150	100

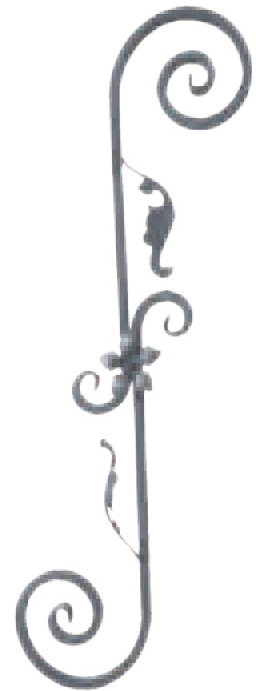

BA-111-35/D	BA-113-35/D	Referencia/Reference	BA-114-35/D	BA-116-35/D
- 12x6, 14x5, 16x6	■ 14, 16	Material/Material	■ 14, 16	■ 14
900	900	Alto/High	1000	900
150	38	Ancho/Wide	38	190

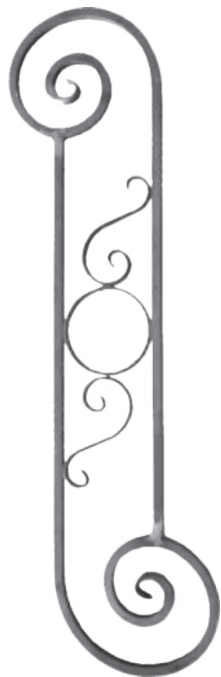

BA-117-35/E	BA-118-35/E	Referencia/Reference	BA-119-35/E	BA-120-35/E
■ 14	■ 14	Material/Material	■ 14	■ 14
900	900	Alto/High	900	900
185	220	Ancho/Wide	220	220



BA-013-29	BA-014-29	Referencia/Reference	BA-032-31	BA-033-31
■ 12, 14	■ 12, 14	Material/Material	■ 12, 14 Martilleada/ Hammered	■ 12, 14 Martilleada/ Hammered
900/1000...	900/1000...	Alto/High	900/1000...	900/1000...
65	65	Ancho/Wide	65	65

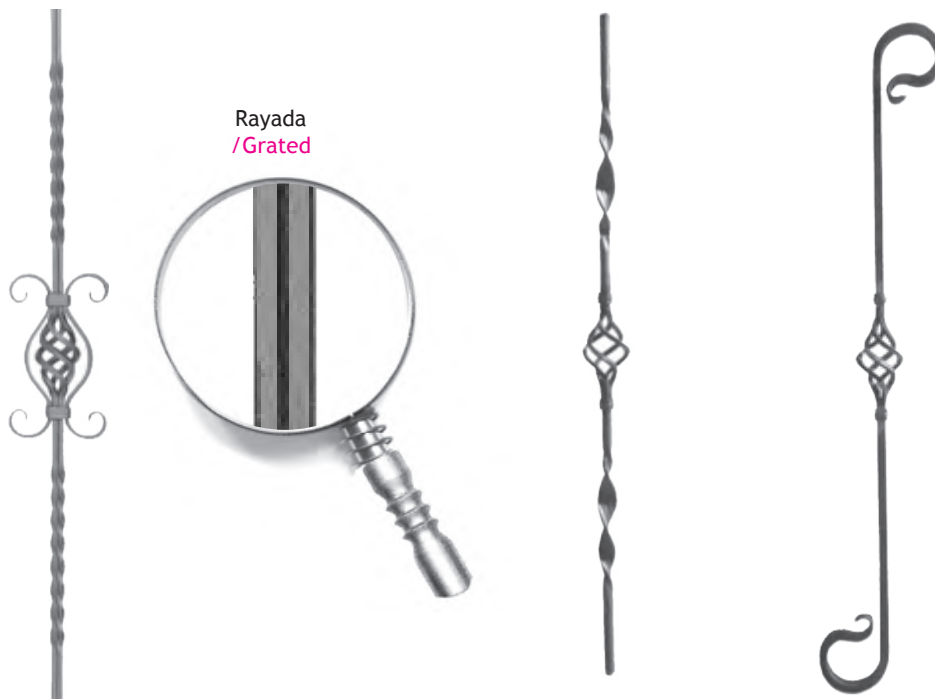

BA-025-30	Referencia/Reference	BA-112-35/D	BA-115-35/D
■ 14 Rallada/ Grated	Material/Material	■ 12, 14	■ 14
900	Alto/High	900	900
130	Ancho/Wide	65	65

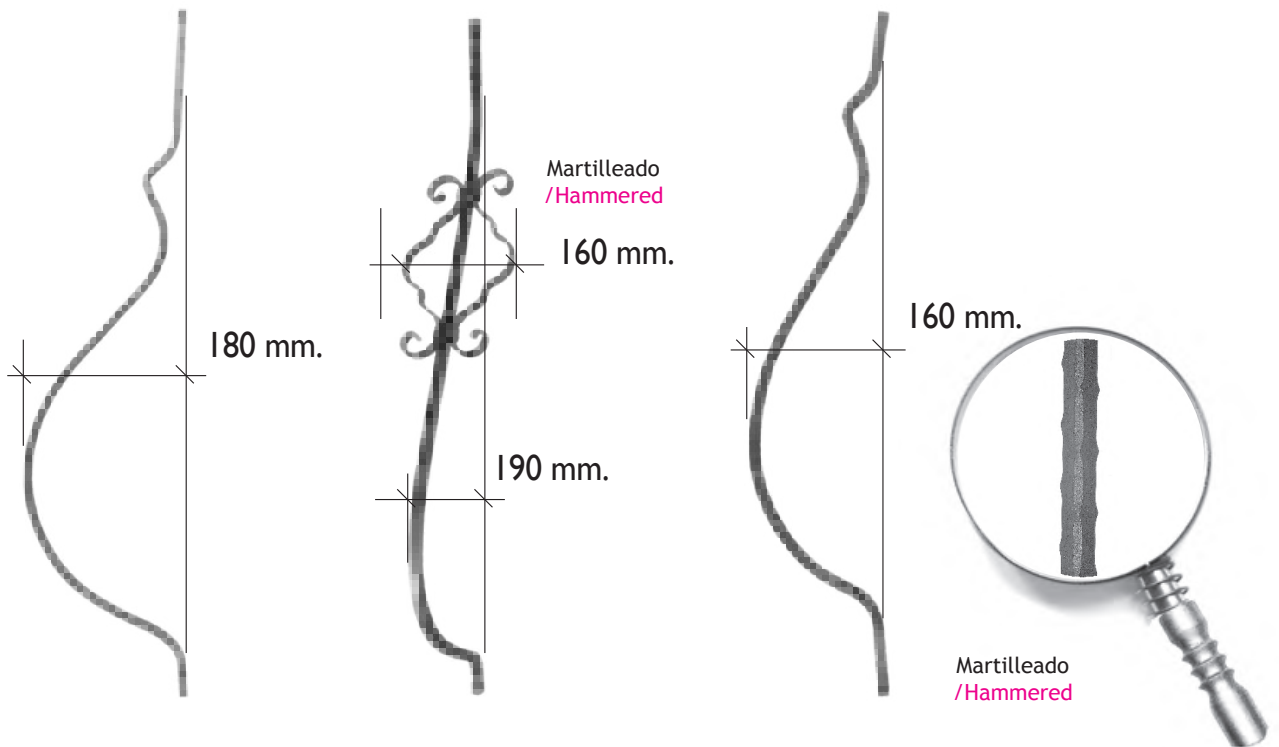

BA-068-34	BA-069-34	BA-070-35	Referencia/Reference
■ 12	■ 12, ■ 14	■ 12 Martilleada/ Hammered	Material/Material
900	900	900	Alto/High
180	190	160	Ancho/Wide

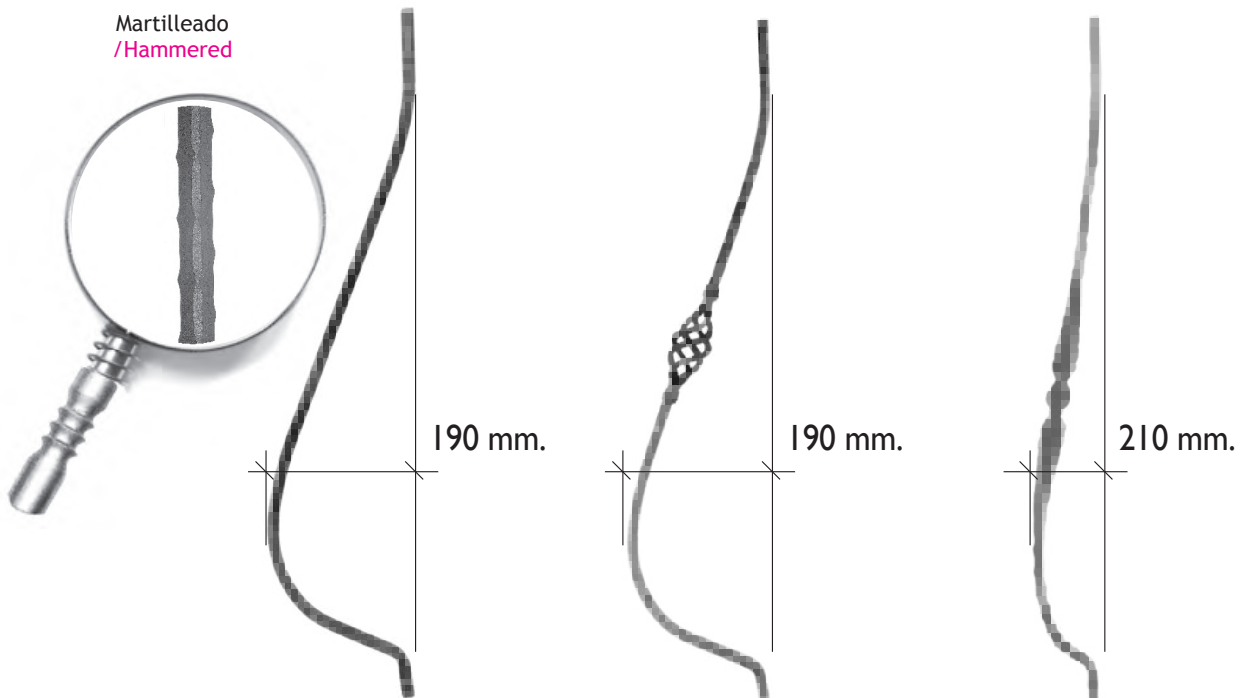

Referencia/Reference	BA-071-35	BA-072-35	BA-073-35
Material/Material	■ 12, ■ 14 Martilleada/ Hammered	■ 12, ■ 14 Martilleada/ Hammered	■ 14 Martilleada/ Hammered
Alto/High	900	900	900
Ancho/Wide	190	190	210



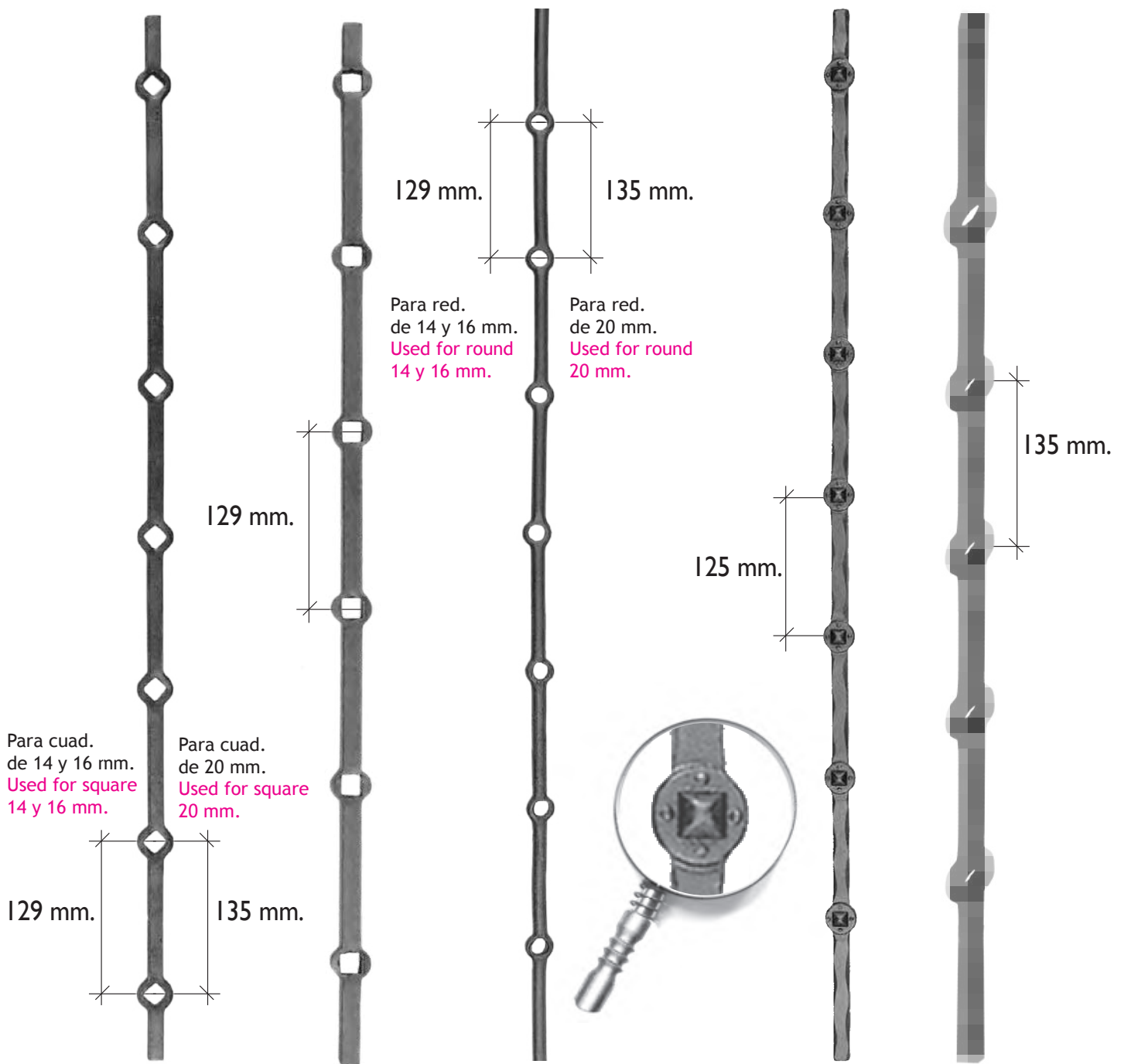

BR-001-36	BR-002-36	BR-003-36	Referencia/Reference	BR-004-36	BR-008-36
■ 14, 16, 20 ■ 20 interior ■ 16	■ 16 interior	● 14, 16, 20	Material/Material	■ 14	◆ 16
2000	2000	2000	Alto/High	2000	2000
14	14	14	Nº Perforaciones/ Estampaciones en barra Nº Holes/Stamps per bar	15	14
Taladro rombo/ Perforated diamod	Taladro plano/ Perforated plane	Taladro redondo/ Perforated round	Observaciones/Observations	Estampado/ Stamped	Taladro rombo en vertice/ Perforated diamod in edge

Debido a las características de la materia prima, las medidas del cuadro pueden sufrir pequeñas variaciones milimétricas.
Due to raw material characteristics, square measures can admit milimetric variations.

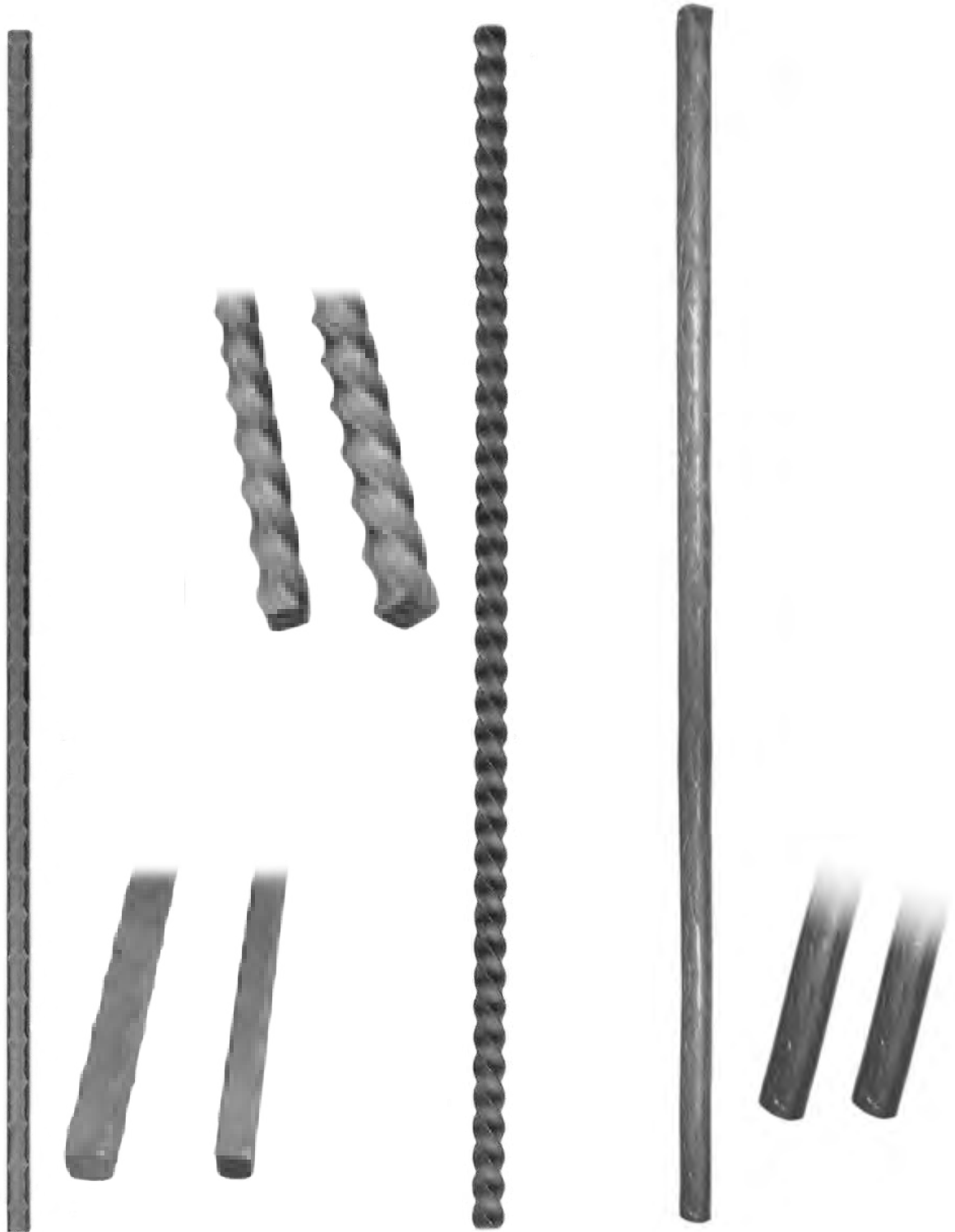

BR-005-37	Referencia/Reference	BR-006-37		BR-007-37
■ 12, 14, 16, 20	Material/Material	■ 12, 14, 16, 20, 25, 30, 40	■ 12, 14, 16, 20, 25	● 12, 14, 16
3000-6000	Alto/High	3000	6000	2900-5800
Martilleada / <i>Hammered</i>	Modelo/Model	Helicoidal / <i>Twisted</i>		Tronco madera / <i>Wood</i>

LAS LONGITUDES EXPRESADAS
SON APROXIMADAS

LENGTHS EXPRESSED
ARE APPROXIMATE

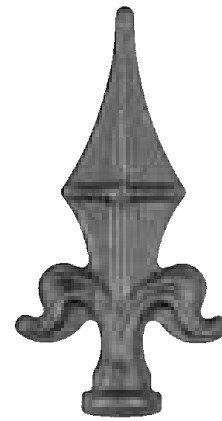
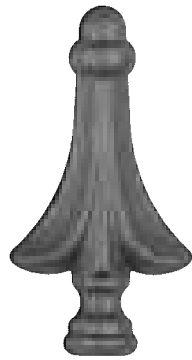

Referencia/Reference	LA-001-38	LA-002-38	LA-001-38
Base diametro/ Base diameter	● 20	● 25	● 38
Alto/High	80	125	140
Ancho/Wide	45	65	80

Referencia/Reference	LA-004-38	LA-005-38
Base diametro/ Base diameter	● 22	● 24
Alto/High	115	140
Ancho/Wide	60	68

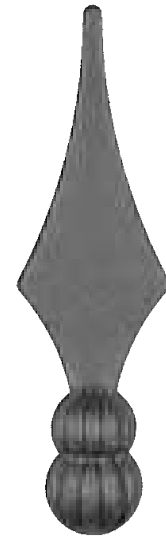
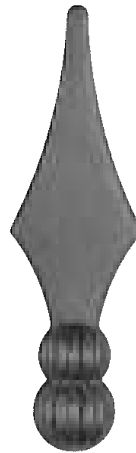

LA-006-38	LA-007-38	Referencia/Reference	LA-008-38	LA-009-38
● 24	● 24	Base diametro/ Base diameter	● 30	● 32
125	135	Alto/High	160	190
40	40	Ancho/Wide	50	54

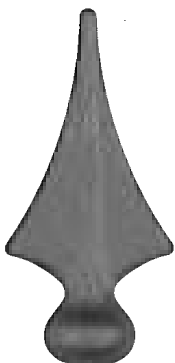

LA-010-39	Referencia/Reference	LA-011-39
● 32	Base diametro/ Base diameter	● 25
125	Alto/High	125
60	Ancho/Wide	45

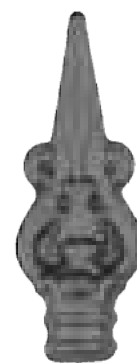

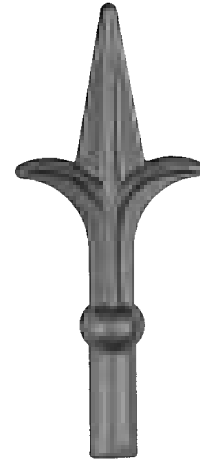
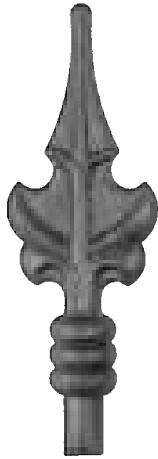

Referencia/Reference	LA-012-39	LA-013-39
Base diámetro/ Base diameter	● 13	● 14
Alto/High	140	180
Ancho/Wide	50	60

Referencia/Reference	LA-014-39	LA-015-39	LA-016-39
Base diámetro/ Base diameter	● 18	● 16	● 12
Alto/High	195	160	128
Ancho/Wide	75	65	53

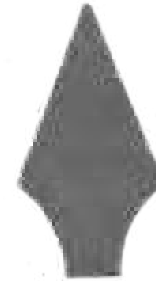
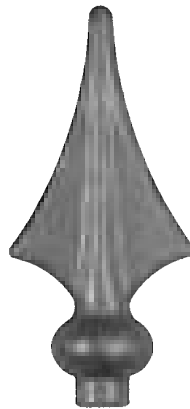

LA-017-40	LA-018-40	Referencia/Reference	LA-019-40
Base diámetro ■ 12 Base diameter	Base diámetro ■ 14 Base diameter	Material/Material	Espesor chapa 4 Thickness
180	140	Alto/High	95
43	60	Ancho/Wide	50

Referencia/Reference	LA-020-40	LA-021-40	LA-022-40
Base diámetro/ Base diameter	● 20	● 16	● 12
Alto/High	190	152	128
Ancho/Wide	92	70	58

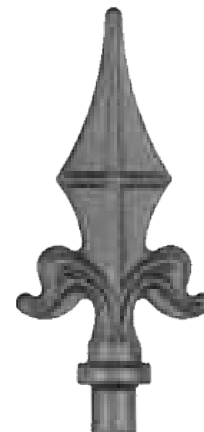



LA-023-41	Referencia/Reference	LA-024-41
Base diámetro ■ 12 Base diameter	Material/Material	Base diámetro ■ 12 Base diameter
167	Alto/High	260
52	Ancho/Wide	43



LA-025-41	Referencia/Reference	LA-026-41
Base diámetro ■ 10 Base diameter	Material/Material	Base diámetro ● 14 Base diameter
138	Alto/High	220
27	Ancho/Wide	67



LA-027-41	Referencia/Reference	LA-028-41
Base diámetro ● 16 Base diameter	Material/Material	Interior ● 16
200	Alto/High	150
40	Ancho/Wide	35



Alojamiento para prisionero
Fixing hole to take grub screw



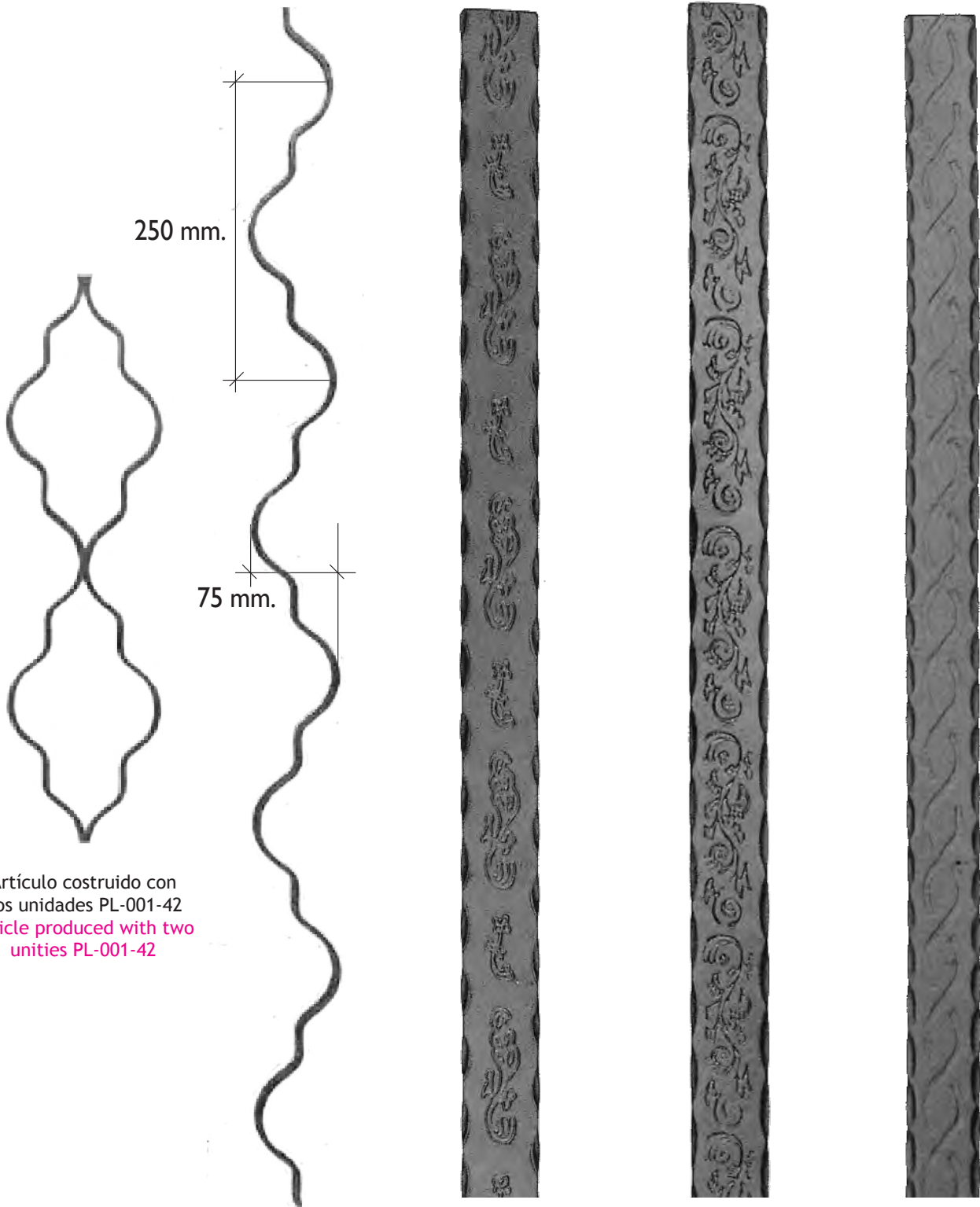

Artículo construido con dos unidades PL-001-42
Article produced with two unities PL-001-42

Referencia/Reference	PL-001-42	PL-002-42	PL-003-42	PL-004-42
Material/Material	- 12x6, 14x5	- 40x8	- 40x8	- 40x8
Longitud/Length	2500	3000-6000	3000-6000	3000-6000
Modelo/Model	-	Labrado discontinuo /Discontinuos	Labrado continuo /Continuos	Labrado enlazado /Lacing

Bajo pedido otras longitudes y materiales
Under order we produce other length and materials

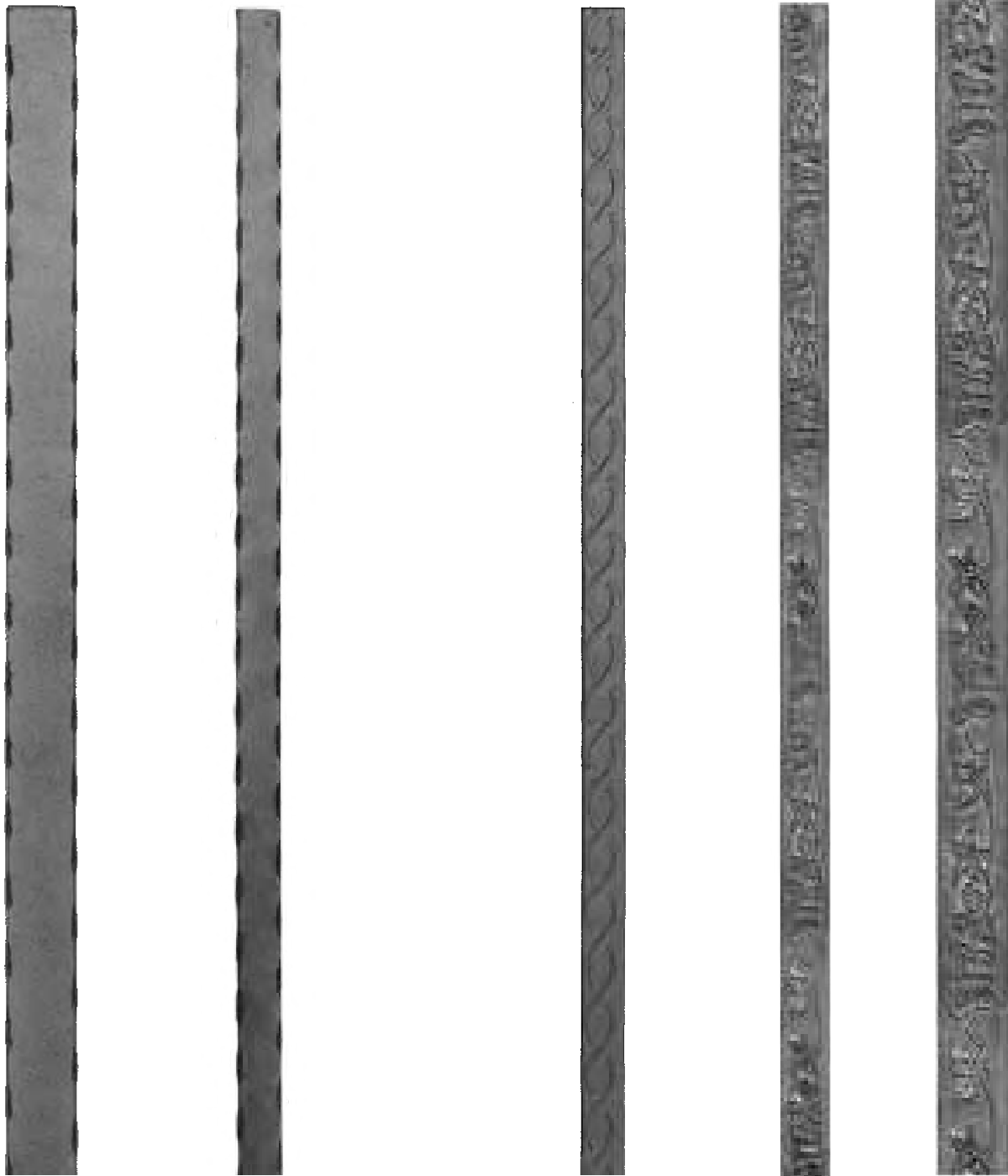

PL-005-43	PL-006-43	Referencia/Reference	PL-007-43	PL-041-43	PL-042-43
- 40x8	- 30x8	Material/Material	- 30x6	- 30x8	- 40x6
3000-6000	3000-6000	Longitud/Length	3000-6000	2900-5800	2900-5800
Martilleada /Hammered	Martilleada /Hammered	Modelo/Model	Labrado enlazado /Lacing	Grabado en relieve /Relief stamp	Grabado en relieve /Relief stamp
PL-005-D-43	PL-006-D-43	Referencia/Reference			
- 40x8	- 30x8	Material/Material			
3000-6000	3000-6000	Longitud/Length			
Martilleada a doble cara /Hammered two sides	Martilleada a doble cara /Hammered two sides	Modelo/Model			



PL-000-43	PL-046-43	PL-050-43	Referencia/Reference	PL-054-43	PL-058-43
- 40x8	- 40x8	- 40x8	Material/Material	- 40x8	- 40x8
3000-6000	3000-6000	3000-6000	Longitud/Length	3000-6000	3000-6000
Labrado ramas /Branch model	Labrado rombo-aro /Diamond-ring	Labrado ola /Wave	Modelo/Model	Labrado estrella /Star	Labrado greca /Greca

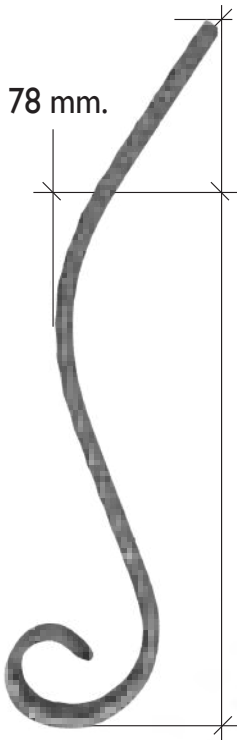

Referencia/Reference	PL-008-44	PL-009-44	PL-010-44	PL-044-44	PL-079-44
Material/Material	- 40x8	- 40x8	- 40x8	- 40x8	- 40x8
Medida/Measure	370x78	370x78	370x78	370x78	370x78
Fabricado con/Produced With	PL-002-42	PL-003-42	PL-004-42	PL-000-42	PL-005-43



Detalle / **Detail**
Ref. PL-002-42

370 mm.



Detalle / **Detail**
Ref. PL-005-43



Detalle / **Detail**
Ref. PL-003-42

575 mm.



150 mm.

Referencia/Reference	PL-011-44	PL-012-44	PL-013-44	PL-045-44	PL-080-44
Material/Material	- 40x8	- 40x8	- 40x8	- 40x8	- 40x8
Medida/Measure	575x150	575x150	575x150	575x150	575x150
Fabricado con/Produced With	PL-002-42	PL-003-42	PL-004-42	PL-000-42	PL-005-43



Detalle / **Detail**
Ref. PL-000-42



215 mm.

90 mm.



Detalle / **Detail**
Ref. PL-004-42

Referencia/Reference	PL-014-44	PL-015-44	PL-016-44	PL-043-44	PL-081-44
Material/Material	- 40x8	- 40x8	- 40x8	- 40x8	- 40x8
Medida/Measure	215x90	215x90	215x90	217x90	217x90
Fabricado con/Produced With	PL-002-42	PL-003-42	PL-004-42	PL-000-42	PL-005-43

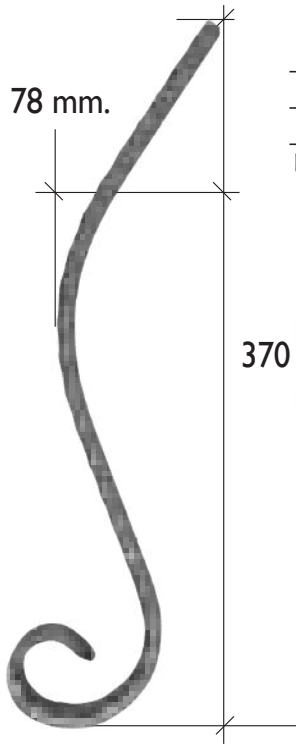

Referencia/Reference	PL-047-43	PL-051-43	PL-055-43	PL-049-43
Material/Material	- 40x8	- 40x8	- 40x8	- 40x8
Medida/Measure	370x78	370x78	370x78	370x78
Fabricado con/Produced With	PL-046-43	PL-050-43	PL-054-43	PL-058-43



Detalle / Detail
Ref. PL-046-43



Detalle / Detail
Ref. PL-050-43



575 mm.

LAS LONGITUDES EXPRESADAS SON APROXIMADAS

LENGTHS EXPRESSED ARE APPROXIMATE

Referencia/Reference	PL-048-43	PL-052-43	PL-056-43	PL-060-43
Material/Material	- 40x8	- 40x8	- 40x8	- 40x8
Medida/Measure	575x150	575x150	575x150	575x150
Fabricado con/Produced With	PL-046-43	PL-050-43	PL-054-42	PL-058-43



Detalle / Detail
Ref. PL-054-43

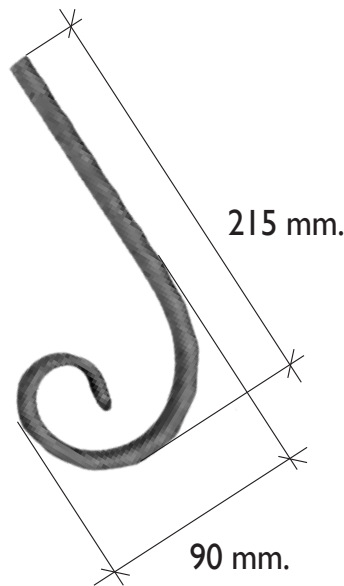

215 mm.

90 mm.



Detalle / Detail
Ref. PL-058-43

Referencia/Reference	PL-049-43	PL-053-43	PL-057-43	PL-061-43
Material/Material	- 40x8	- 40x8	- 40x8	- 40x8
Medida/Measure	215x90	215x90	215x90	217x90
Fabricado con/Produced With	PL-046-43	PL-050-43	PL-054-43	PL-058-43



PLETINAS/FLAT BARS

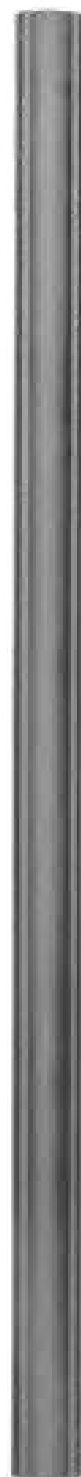

PL-017-45	PL-018-45	Referencia/Reference	PL-020-45	PL-021-45
- 40x8 ± 10	- 50x8 ± 10	Material/Material	- 40x8 ± 10	- 50x8 ± 10
2900-5800	2900-5800	Longitud/Length	2900-5800	2900-5800
Pasamano media caña /Half moon Handrail	Pasamano media caña /Half moon Handrail	Modelo/Model	Pasamano forma /Style Handrail	Pasamano forma /Style Handrail

**RECUERDE: FABRICAMOS OTRAS
MEDIDAS BAJO PEDIDO
REMEMBER: WE PRODUCE OTHER
MEASURES UNDER ORDER**



PL-023-46	PL-024-46	Referencia/Reference	PL-026-46	PL-027-46
- 40x8 ± 10	- 50x8 ± 10	Material/Material	- 40x8 ± 10	- 50x8 ± 10
370x78	370x78	Medida/Measure	370x78	370x78
PL-017-45	PL-018-45	Fabricado con/Produced With	PL-020-45	PL-021-45

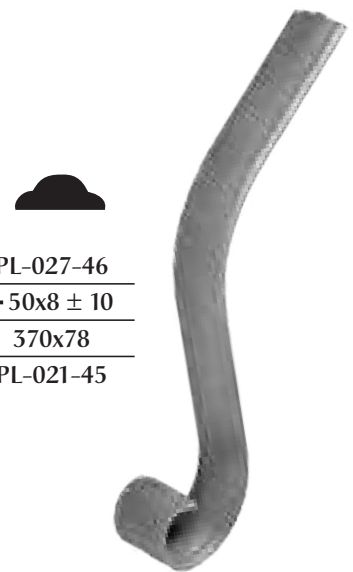

PL-029-46	PL-030-46	Referencia/Reference	PL-032-47	PL-033-47
- 40x8 ± 10	- 50x8 ± 10	Material/Material	- 40x8 ± 10	- 50x8 ± 10
575x150	575x150	Medida/Measure	575x150	575x150
PL-017-45	PL-018-45	Fabricado con/Produced With	PL-020-45	PL-021-45

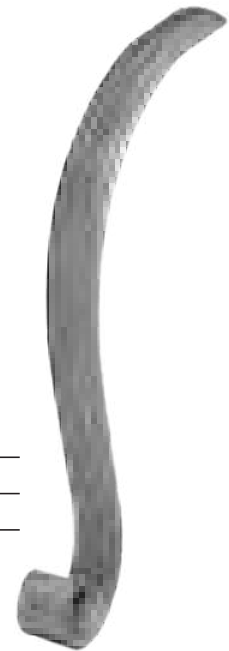

PL-035-47	PL-036-47	Referencia/Reference	PL-038-47	PL-039-47
- 40x8 ± 10	- 50x8 ± 10	Material/Material	- 40x8 ± 10	- 50x8 ± 10
215x90	215x90	Medida/Measure	215x90	215x90
PL-017-45	PL-018-45	Fabricado con/Produced With	PL-020-45	PL-021-45

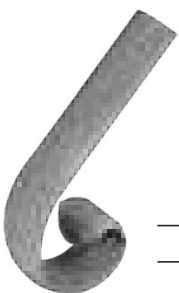

Pletinas Perforadas/Perforated flat bars.

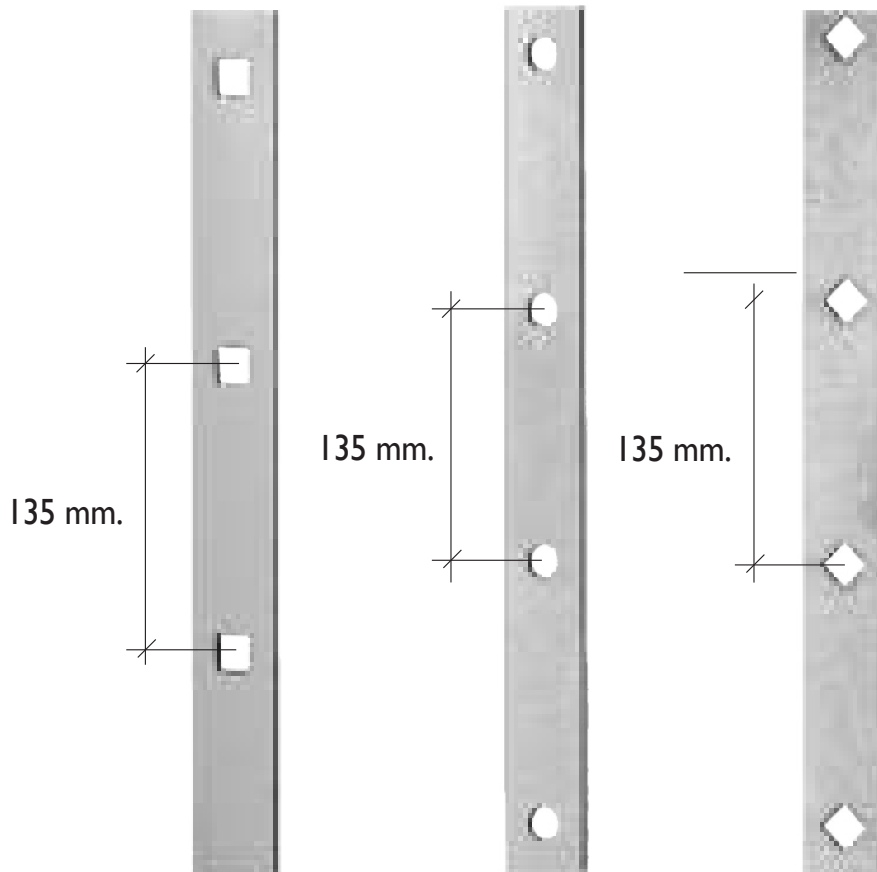

Referencia/Reference	PL-062-43	PL-063-43	PL-064-43
Medida taladro/Drill	■ 12, 14, 16	● 12, 14, 16	◆ 12, 14, 16
Material/Material	- 30x6, 30x8, 40x6,40x8	- 30x6, 30x8, 40x6,40x8	- 30x6, 30x8, 40x6,40x8
Medida taladro/Drill	■ 18, 20	● 18, 20	◆ 18, 20
Material/Material	- 40x6,40x8	- 40x6,40x8	- 40x6,40x8
Longitud/Length	2000	2000	2000

Bajo pedido, fabricamos en otros materiales y otros diámetros de taladro
 Under order, other materials and types of punches.

Curvas escalera de caracol/Staircase spiral's curves.

Referencia/Reference	PL-065-43	PL-067-43	PL-068-43	PL-069-43
Material/Material	- 40x6	- 40x8	- 40x8	- 40x8
Fabricado con/Produced With	-	-	PL-002-42	PL-003-42

Referencia/Reference	PL-070-43	PL-071-43	PL-072-43	PL-073-43
Material/Material	- 40x8	- 40x8	- 30x8	- 30x6
Fabricado con/Produced With	PL-004-42	PL-005-43	PL-006-43	PL-007-43

Referencia/Reference	PL-074-43	PL-075-43	PL-076-43	PL-077-43	PL-078-43
Material/Material	- 40x8	- 40x8	- 40x8	- 40x8	- 40x8
Fabricado con/Produced With	PL-000-43	PL-046-43	PL-050-43	PL-054-43	PL-058-43

Diámetro/Diameter: 600, 700, 800, 900, 1000 mm.

Observaciones/Remarks: Derecha - Izquierda / Right - Left

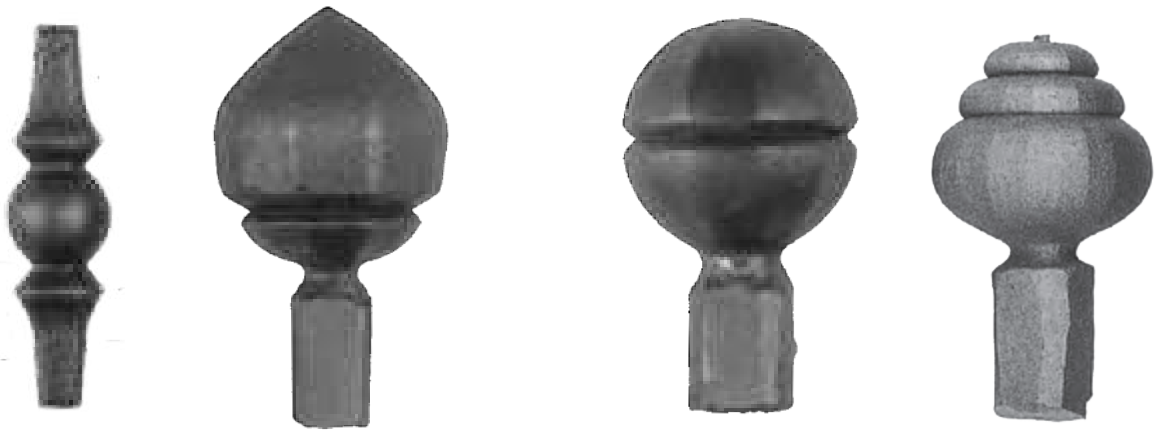

RE-001-48	RE-002-48	Referencia/Reference	RE-003-48	RE-028-49/A
■ 12 ÷ 14	■ 25	Material/Material	■ 25	■ 30
128	125	Alto/High	120	120
34	70	Ancho/Wide	70	75

Referencia/Reference	RE-004-48	RE-005-48	RE-006-48	RE-007-48
Base	33	38	45	50
Alto/High	40	60	75	90
Ancho/Wide	28	45	50	65
Material/Material	Maciza/Solid	Maciza/Solid	Maciza/Solid	Maciza/Solid

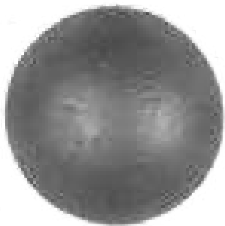

Referencia/Reference	RE-008-48	RE-009-48	RE-010-48	RE-011-48	RE-012-48
Material/Material	Maciza/Solid	Maciza/Solid	Maciza/Solid	Maciza/Solid	Maciza/Solid
Diametro/Diameter	20	25	30	35	40

Referencia/Reference	RE-013-49	RE-014-49	RE-015-49	RE-016-49
Material/Material	Maciza/Solid	Maciza/Solid	Maciza/Solid	Maciza/Solid
Diametro/Diameter	45	50	60	70

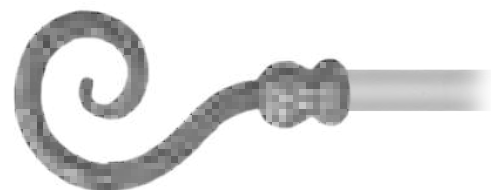

Remates cortineros
Curtains terminations

RE-017-49	Referencia/Reference	RE-018-49
Interior ● 16	Material/Material	Interior ● 16
55	Alto/High	75
140	Ancho/Wide	140

Remates cortineros Curtains terminations

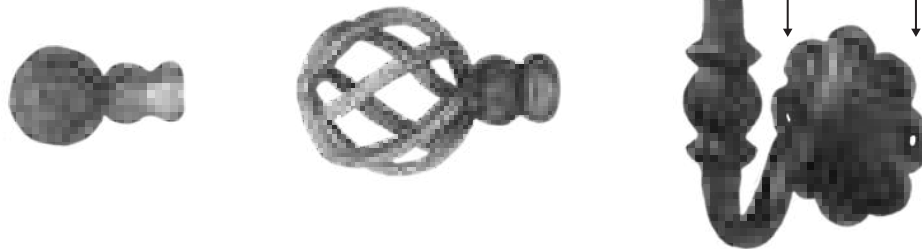

Referencia/Reference	RE-019-49	RE-020-49	RE-021-49
Material/Material	Interior ● 16	Interior ● 16	■ 14
Alto/High	45	70	180
Ancho/Wide	80	105	95

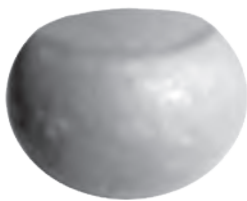

Referencia/Reference	RE-022-49/A	RE-023-49/A	RE-024-49/A
Alto/High	35	28	22
Ancho/Wide	55	45	35
Observaciones/Remarks	Esfera maciza aplastada Solid platted sphere	Esfera maciza aplastada Solid platted sphere	Esfera maciza aplastada Solid platted sphere

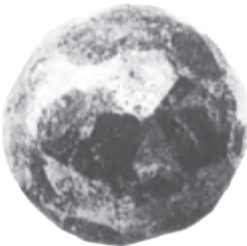

Referencia/Reference	RE-025-49/A	RE-026-49/A	RE-027-49/A
Diametro/Diameter	● 50	● 40	● 30
Observaciones/Remarks	Esfera maciza Martilleada/ Solid hammered sphere	Esfera maciza Martilleada/ Solid hammered sphere	Esfera maciza Martilleada/ Solid hammered sphere



Referencia/Reference	RE-029-49/A	RE-030-49/A	RE-031-49/A
Alto/High	110	125	155
Ancho/Wide	-	-	-
Observaciones/Remarks	Bisagra ornamental Ornamental hinge	Bisagra ornamental Ornamental hinge	Bisagra ornamental Ornamental hinge

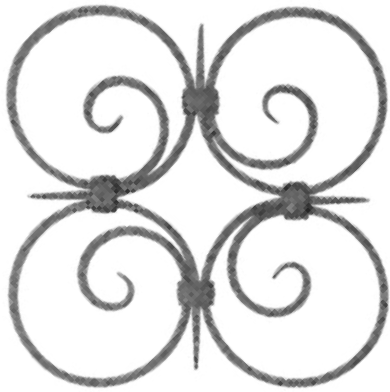

Referencia/Reference	RO-001-50
Material/Material	- 14x5
Alto/High	242
Ancho/Wide	242

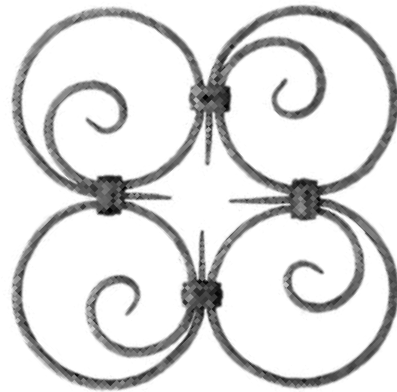

Referencia/Reference	RO-001-I-50
Material/Material	- 14x5
Alto/High	242
Ancho/Wide	242

**LAS LONGITUDES EXPRESADAS
SON APROXIMADAS**

**LENGTHS EXPRESSED
ARE APPROXIMATE**

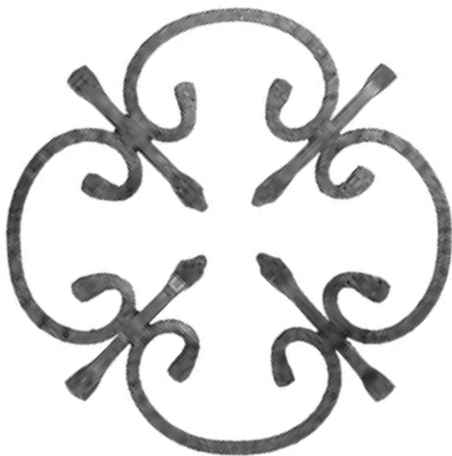

Referencia/Reference	RO-002-50
Material/Material	■ 8
Alto/High	255
Ancho/Wide	255

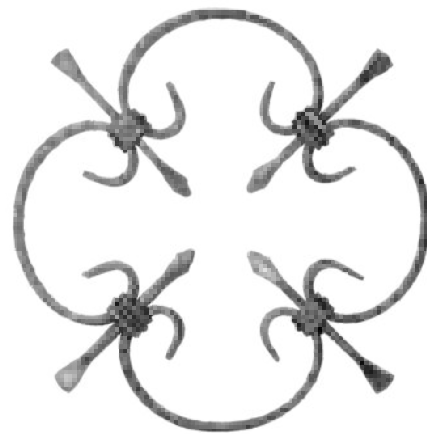

Referencia/Reference	RO-003-50
Material/Material	- 10x5
Alto/High	250
Ancho/Wide	250

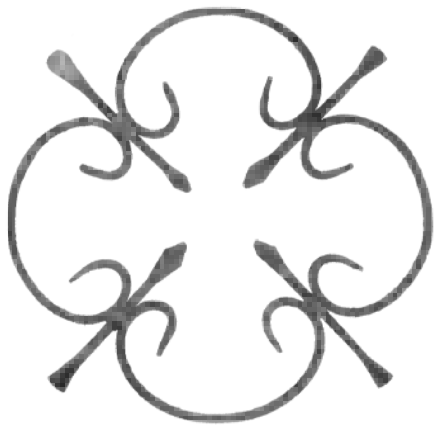

Referencia/Reference	RO-004-51
Material/Material	- 10x5
Alto/High	250
Ancho/Wide	250

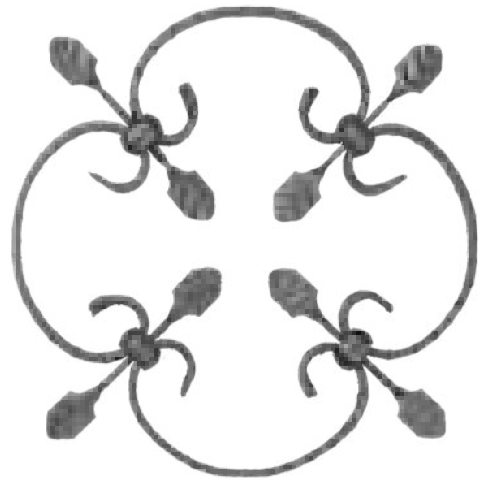

Referencia/Reference	RO-005-51
Material/Material	- 20x4
Alto/High	255
Ancho/Wide	255

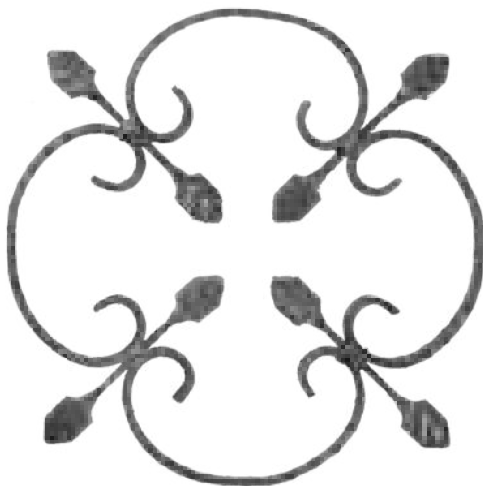

Referencia/Reference	RO-006-51
Material/Material	- 20x4
Alto/High	255
Ancho/Wide	255

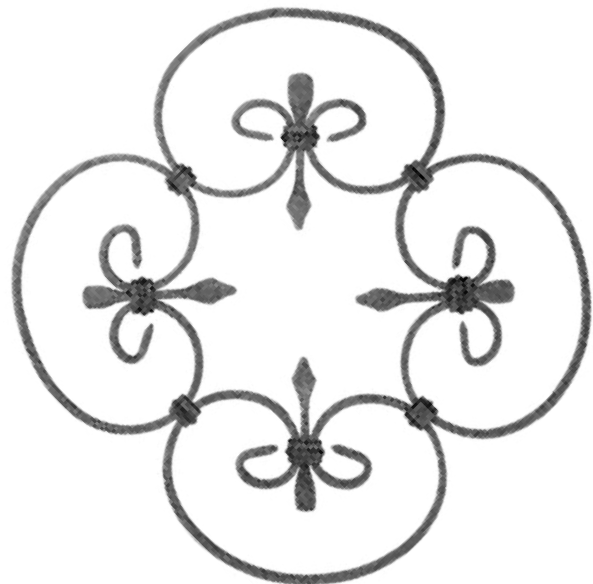

Referencia/Reference	RO-007-50
Material/Material	- 10x5
Alto/High	385
Ancho/Wide	385